

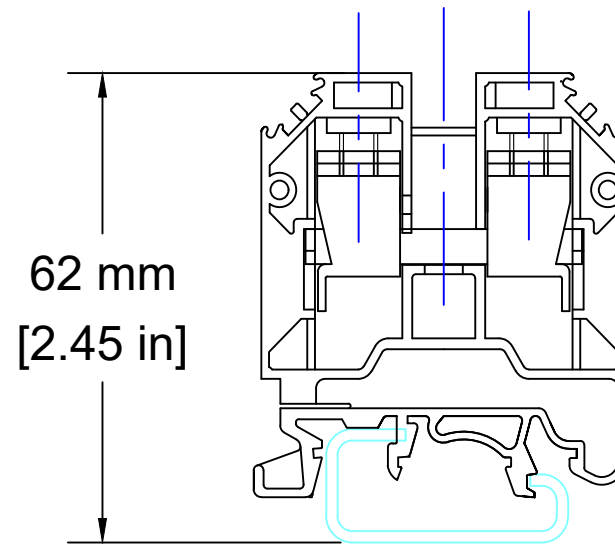

DIN 35



DIN 32

<p>TOLERANCE:</p> <p>.XX +/- 0.02 .XXX +/- 0.005 .XXXX +/- 0.001 ANGLES +/- 0.5 DEG</p> <p>UNLESS OTHERWISE SPECIFIED</p>	 <small>since 1976</small>	
	<p>P.O. BOX 496 BEAVER, PA 15009 www.c3controls.com</p>	
<p>This drawing is the property of c3controls. The drawing may not be copied, used or disclosed, for any purpose except as authorized in writing by c3controls.</p>	<p>Description: WTB2-W25 OUTLINE DIMENSION DRAWING</p>	
	<p>Drawn By: P. DAMESIMO</p>	<p>Drawing Number:</p>
	<p>Date: 12-16-2005 Scale: 1:1</p>	<p>25T30006</p>