

**CODE : 41312**

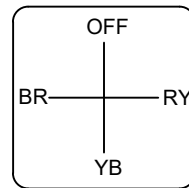

Z9312

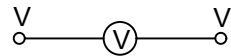
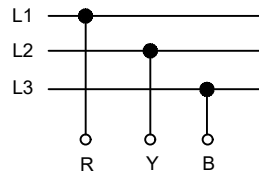
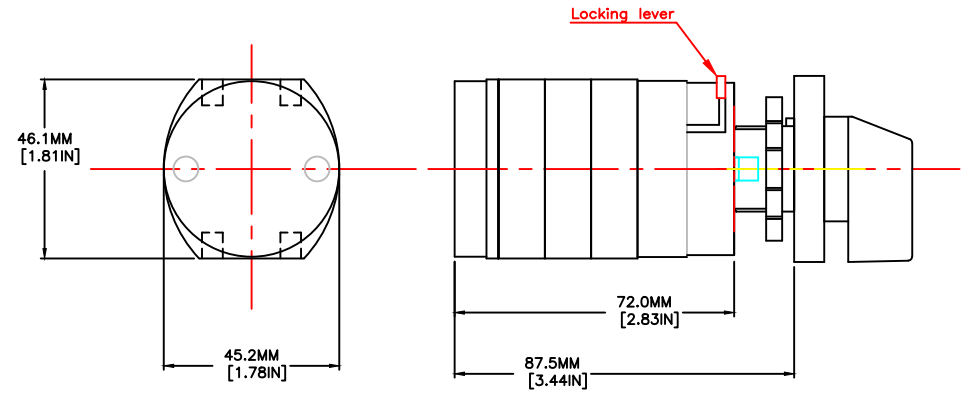

**CODE : 41313**

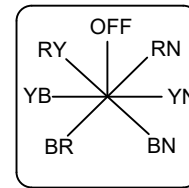
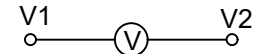
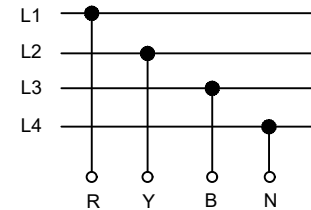

Z4313

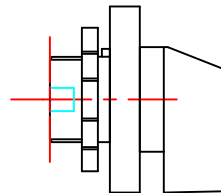

**L22 HANDLE SHOWN  
ALSO SPECIFY N22**

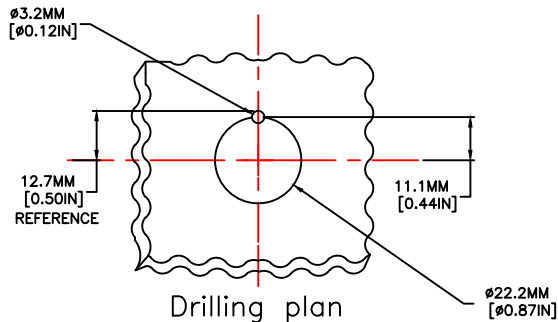

16A

**60C10041**

<p><b>tolerance:</b>          .XX +/- 0.02          .XXX +/- 0.005          .XXXX +/- 0.001          ANGLES +/- 0.5 DEG</p>		<p><b>Resonance:</b>          P.O. BOX 496 BEAVER, PA 15009 www.c3controls.com</p>	
<p>UNLESS OTHERWISE SPECIFIED</p>		<p><b>Product:</b> VOLTMETER Switch          with OFF Position          SERIES 41312 &amp; 41313          16A Product OUTLINES</p>	
<p>This drawing is the property of c3controls. The drawing may not be copied, used or disclosed, for any purpose except as authorized in writing by c3controls.</p>		<p>Drawn By: RJJ</p>	<p>Drawing Number: 60C10041</p>
<p>Date: 11-13-06</p>		<p>Scale: 1:1</p>	<p>60C10041</p>