



GENERAL PURPOSE RELAYS



c3controls offers a full line of General Purpose Relays (“plug-in” relays), perfect for your control logic applications. Quick and economical to install, our relays allow for easy maintenance and assembly, and come in a variety of base configurations. Options include LED indicators and manual lockable push buttons among others. Our relays meet UL, CSA, and IEC standards requirements making them suitable for global applications.

	Section 35
Square Base Relays w/Blade	4
Octal Base Relays w/Pin	10
Pin & Blade Sockets	14
Dimensions	17

PROVEN



Conformity to Standards:
GENERAL PURPOSE RELAYS
 UL 508
 CSA C22.2 No. 14-18
 IEC/EN 61810-1:2008

Certifications:
 UL File #: E224085
 CE Marked (As per the Low Voltage Directive 2014/35/EU, and RoHS Directive 2015/863/EU)



SOCKETS
 UL 508
 CSA C22.2 No. 14-18
 IEC/EN 61810-1:2008

UL File #: E236196
 CE Marked (As per the Low Voltage Directive 2014/35/EU, and RoHS Directive 2015/863/EU)

Visit c3controls.com to download product certifications.

NOTE: The scope (range, description, price, specifications, dimensions, etc.) of the product featured in this section is subject to change without notice. Refer to c3controls.com for product updates.

GENERAL PURPOSE RELAYS



Every c3controls product is designed and manufactured to meet the needs of the machine builder, including our comprehensive line of General Purpose Relays. Check out all the features of our Series 200 and 210 below!

QUICK AND ECONOMICAL—PERFECT FOR ALL YOUR CONTROL LOGIC APPLICATIONS.

✓ Proven	Our relays meet UL, CSA, and IEC standards requirements making them suitable for global applications.	
✓ Multiple Styles	Our line of General Purpose Relays are available in Octal Base with pin terminals and Square Base with blade-style terminals.	
✓ Convenient Customization	Our Series 210 Octal Base relays with pin style terminals are interchangeable with other commonly available relays.	
✓ Easy Reference	Schematic diagrams and terminal markings are located on the relay for easy reference during installation.	
✓ Transparent Housing	Allows you to see switching operations and the condition of the contacts.	
✓ Wide Range of Specifications	Various pole combinations, such as SPDT, DPDT, 3PDT, and 4PDT, are in stock for same-day delivery, featuring a current rating up to 10A. Additionally, SPST, DPST, 3PST, 1 NO + NC contacts, and 1 NO Double break contacts are also offered; however, their availability is contingent on lead time and minimum order quantities.	
✓ Environmentally Safe	Our AgNi contacts are cadmium-free and environmentally friendly.	
✓ Limited Lifetime Warranty*	Every product is backed by our limited lifetime warranty—unmatched in the industry—bringing you quality components that perform in the most demanding applications.	
✓ Guaranteed Same-Day Shipping*	Product availability reduces inventory and improves cash flow—saving you money. With c3controls any order for standard catalog items received by 6:00 pm ET is guaranteed to ship same-day.	
✓ Advantage Pricing	Our approach to product development, manufacturing, and focus on servicing the OEM and Electrical Equipment Builder reduces cost. The result—the best value in the industry.	

*See c3controls Terms & Conditions

Square Base 1 Pole with Blade Terminals



Square Base 2 Pole with Blade Terminals

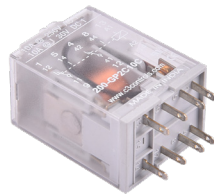

Square Base 4 Pole with Blade Terminals

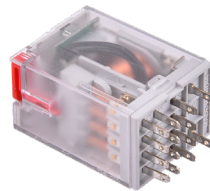

Octal Base 2 Pole with Pin Terminals



Octal Base 3 Pole with Pin Terminals

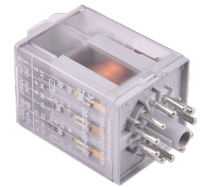

UNIQUE PRODUCT LINE FEATURES

RELIABILITY REDEFINED

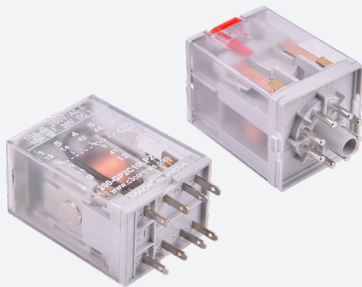

Our General Purpose Relays ensure consistent, trouble-free performance for smooth system operation.

ENHANCED CONTROL AND SAFETY

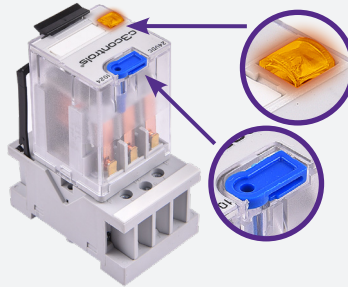

Opt for our manual push button with an indicator for safe circuit checks without relay energization.

QUICK IDENTIFICATION

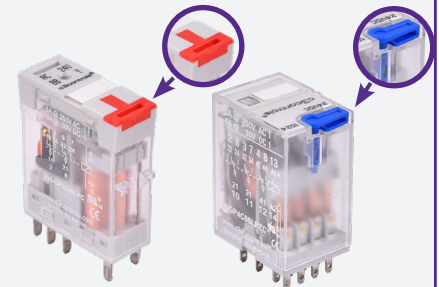

Relay coil voltages are printed for easy identification. Color-coded push buttons distinguish DC (blue) and AC (red) controls for simplified operation.

MARKING STRIPS

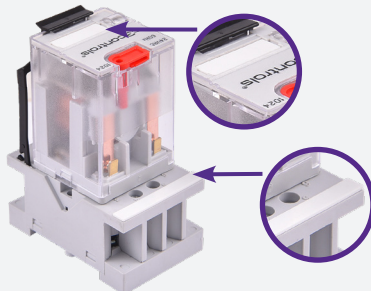

Marking plates at relays and sockets to provide easy identification, improving maintenance efficiency and minimizing errors.

INBUILT RETAINER CLIPS



Built-in plastic retainer clips in relay sockets ensure secure and hassle-free relay installation and replacement.

VERSATILE APPLICATIONS

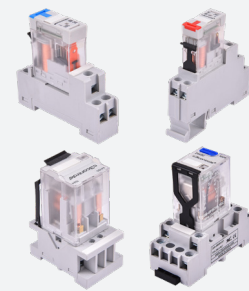

Our relays seamlessly adapt to industrial, commercial, and residential applications, making them the ideal choice for diverse settings.

FIND IT FAST

General Purpose Relays



- Certifications
- Specifications
- Dimension Drawings
- Installation Instructions
- Easy to Buy

c3controls.com

SQUARE BASE 1 POLE RELAYS WITH BLADE TERMINALS

- SPDT and SPST relays with a 10A rating provide flexibility for control circuit applications.
- Coil voltages printed on top of relays for easy identification, ensuring the right choice for your application.
- Our color-coded push buttons simplify operation by clearly distinguishing between DC (blue) and AC (red) controls.
- Comprehensive selection of coil voltages, ranging from 12V to 230V AC and 12V to 110V DC.
- Low coil consumption to minimize transformer and power supply requirements.
- Transparent housing designed for visual observation of switching mechanisms and contact points, allowing for real-time assessment of operational and wear status.
- Small size requiring minimum panel space for lower installed cost.
- Schematic diagram and terminal markings on the relay for easy reference during installation.
- Optional manual and lockable push button and LED indicator for checking the control circuit operation without energizing the relay and to easily determine the relay status.
- 100% tested to ensure performance to specification.
- UL, CSA and CE for acceptance in global applications.
- AgNi contacts, environmentally friendly - cadmium-free.

IT'S EASY TO BUILD YOUR OWN RELAY

Simply pick the code number from each of the sections below and combine them to build your part number.

Square Base 1 Pole Relay with Blade Terminals

200-GP **10** **II** **IV** **V**

Example: To build one of our most popular Relays, the part number would be **200-GP + II + 10 + IV + V** or **200-GP1C10C**



I. RELAY TYPE

CODE	DESCRIPTION
200-GP	General Purpose Relay

II. POLES / CONTACT TYPE

CODE	DESCRIPTION	LIST
1X	SPST (1 N.O.)*	\$20.00
1C	SPDT (1 C/O)	\$11.00

III. CURRENT RATING

CODE	DESCRIPTION
10	10 Amps

IV. OPTIONS

CODE	DESCRIPTION	LIST
(Blank)	No Options	—
LP	LED Indicator, Manual and Lockable Push Button	\$ 2.00
LPW	LED Indicator, Manual and Lockable Push Button with Free Wheeling Diode*	\$10.00
LPG	LED Indicator, Manual and Lockable Push Button with Free Wheeling Diode and Polarity Diode*	\$12.00
LPR	LED Indicator, Manual and Lockable Push Button with RC Circuit*	\$16.00
LPH	LED Indicator, Manual and Lockable Push Button with Bridge Rectifier*	\$12.00

V. COIL VOLTAGE

CODE	DESCRIPTION	FOR OPTION CODES
B	12V AC*	LP
C	24V AC	LP, LPH
J	48V AC*	LP, LPH
U	115V AC	LP, LPR
V	230V AC	LP, LPR
ZB	12V DC	LP, LPW, LPG
ZC	24V DC	LP, LPW, LPG, LPH
ZJ	48V DC*	LP, LPW, LPG, LPH
ZD	110V DC*	LP, LPW, LPG

*NOTE: Products marked with * are not available for same-day shipping. Please contact our Customer First Team for lead times and minimum order quantities.

DISCOUNT SCHEDULE **G**

COMPATIBLE SOCKETS

RELAY TYPE	COMPATIBLE SOCKETS
200-GP1C10**	200-SB05100 with Screw Clamp Terminals (Guarded) or
200-GP1X10**	200-SB0510B* with Box Terminals

NOTE: ** Represents the Options and Coil Voltage codes. Refer to charts IV & V above. See page 14 for socket information.

SPECIFICATIONS:

SQUARE BASE 1 POLE RELAYS						
	UNITS	200-GP1C10** & 200-GP1X10**				
CONTACTS						
Maximum Switching Current	A	10				
Maximum Peak Inrush Current (20ms)	A	30				
Maximum Switching Voltage	V	250				
Maximum AC Load	kVA	2.5				
Resistive Load	PF = 1.0	250 VAC - 10A 30 VDC - 10A				
Inductive Load	PF = 0.4 (L/R = 7 mSec)	220 VAC - 5A 110 VAC - 7.5A 30 VDC - 5A				
Motor Load		240 VAC - 1/3 HP 120 VAC - 1/4 HP				
Minimum Recommended Load		10 VDC - 10mA				
INSULATION						
Dielectric Strength (1 minute)						
Open Contacts	kV	1				
Between Contacts and Coil	kV	5				
Insulation Resistance @ 500 VDC	Ω	>3G				
COILS (Ohms ±10% @ 20°C)						
VOLTAGE		Coil Resistance (+/- 10% OHMS)	Power Consumption	Pick-Up Voltage	Drop-Out Voltage	Maximum Allowed Voltage
12V AC		80	1.1 VA	≤85% of Nominal Voltage	≥ 30% of Nominal Voltage	110% of Rated Voltage
24V AC		290				
48V AC		1,200				
115V AC		7,300				
230V AC		28,800				
12V DC		224	0.7 W	≤75% of Nominal Voltage	≥ 10% of Nominal Voltage	110% of Rated Voltage
24V DC		742				
48V DC		3,500				
110V DC		19,900				
ENVIRONMENTAL						
Operate Time + Bounce Time	ms	10				
Release Time + Bounce Time	ms	8				
Ambient Temperature		-40°C to +70°C (-40°F to +158°F)				
Mechanical Life Operations		10 Million AC, 20 Million DC Relays				
Electrical Life @ Nominal Load	ops	>100,000				
Operating Frequency @ Nominal Load		1,200/hour				
Protection		IP40 / RT1				
Weight	gms	21				
ROHS COMPLIANCE		For RoHS compliance documentation by product, refer to c3controls.com				

SQUARE BASE 2 POLE RELAYS WITH BLADE TERMINALS

- DPDT and DPST relays with ratings of 6 Amps and 10 Amps provide options for control circuit applications.
- Coil voltages printed on top of relays for easy identification, ensuring the right choice for your application.
- Our color-coded push buttons simplify operation by clearly distinguishing between DC (blue) and AC (red) controls.
- Comprehensive selection of coil voltages, ranging from 6V to 230V AC and 12V to 220V DC.
- Low coil consumption to minimize transformer and power supply requirements.
- Transparent housing designed for visual observation of switching mechanisms and contact points, allowing for real-time assessment of operational and wear status.
- Small size requiring minimum panel space for lower installed cost.
- Schematic diagram and terminal markings on the relay for easy reference during installation.
- Optional manual and lockable push button and LED indicator for checking the control circuit operation without energizing the relay and to easily determine the relay status.
- 100% tested to ensure performance to specification.
- UL, CSA and CE for acceptance in global applications.
- AgNi contacts, environmentally friendly - cadmium-free.

IT'S EASY TO BUILD YOUR OWN RELAY

Simply pick the code number from each of the sections below and combine them to build your part number.

Square Base 2 Pole Relay with Blade Terminals

200-GP

I II III IV V

Example: To build one of our most popular Relays, the part number would be **200-GP + II + III + IV + V** or **200-GP2C10C**

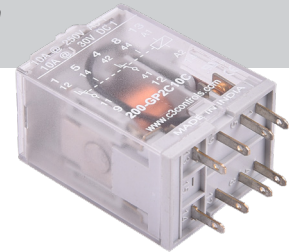

I. RELAY TYPE

CODE	DESCRIPTION
200-GP	General Purpose Relay

II. POLES / CONTACT TYPE

CODE	DESCRIPTION	LIST
2X	DPST (2 N.O.)*	\$17.40
2C	DPDT (2 C/O)	\$10.00
2XY	DPST (1 N.O. + 1 N.C.)*	\$13.90

III. CURRENT RATING

CODE	DESCRIPTION	LIST
10	10 Amps	\$ 2.60
06	6 Amps	—

*NOTE: 6 Amp rating not available with 2XY contact or Coil Voltages 110V AC and 220V DC.

IV. OPTIONS

CODE	DESCRIPTION	LIST
(Blank)	No Options	—
LP	LED Indicator, Manual and Lockable Push Button	\$ 2.00
LPW	LED Indicator, Manual and Lockable Push Button with Free Wheeling Diode*	\$10.00
LPG	LED Indicator, Manual and Lockable Push Button with Free Wheeling Diode and Polarity Diode*	\$12.00
LPR	LED Indicator, Manual and Lockable Push Button with RC Circuit*	\$16.00
LPH	LED Indicator, Manual and Lockable Push Button with Bridge Rectifier*	\$12.00

V. COIL VOLTAGE

CODE	DESCRIPTION	FOR OPTION CODES
A	6V AC*	LP
B	12V AC*	LP
C	24V AC	LP, LPH
J	48V AC*	LP, LPH
I	110V AC*	LP
U	115V AC	LP, LPR
V	230V AC	LP, LPR
ZB	12V DC*	LP, LPW, LPG
ZC	24V DC	LP, LPW, LPG, LPH
ZJ	48V DC*	LP, LPW, LPG, LPH
ZD	110V DC	LP, LPW, LPG
ZE	220V DC*	LP, LPW, LPG

*NOTE: Products marked with * are not available for same-day shipping. Please contact our Customer First Team for lead times and minimum order quantities.



COMPATIBLE SOCKETS

RELAY TYPE	COMPATIBLE SOCKETS
200-GP2C06** 200-GP2X06**	200-SB08060 with Screw Clamp Terminals (Guarded) or 200-SB0806B* with Box Terminals
200-GP2C10** 200-GP2X10** 200-GP2XY10**	200-SB08100 with Screw Clamp Terminals (Guarded) or 200-SB0810B* with Box Terminals

NOTE: ** Represents the Options and Coil Voltage codes. Refer to charts IV & V above. See page 14 & 15 for socket information.

SPECIFICATIONS:

SQUARE BASE 2 POLE RELAYS						
	UNITS	200-GP2C06** / 200-GP2X06**	200-GP2C10** / 200-GP2X10**	200-GP2XY10**		
CONTACTS						
Maximum Switching Current	A	6	10	10		
Maximum Peak Inrush Current (20 ms)	A	30	30	30		
Maximum Switching Voltage	V	250	250	250		
Maximum AC Load	kVA	1.5	2.5	2.5		
Resistive Load	PF = 1.0	250 VAC - 6A 30 VDC - 6A	250 VAC - 10A 30 VDC - 10A	250 VAC - 10A 30 VDC - 10A		
Inductive Load	PF = 0.4 (L/R = 7 mSec)	120 VAC - 2A 28 VDC - 2A	220 VAC - 5A 110 VAC - 7.5A 30 VDC - 7.5A	220 VAC - 5A 110 VAC - 7.5A 30 VDC - 7.5A		
Motor Load			240 VAC - 1/2 HP 120 VAC - 1/2 HP	240 VAC - 1/2 HP 120 VAC - 1/2 HP		
Minimum Recommended Load		10 VDC - 10mA	10 VDC - 10mA	10 VDC - 10mA		
INSULATION						
Dielectric Strength (1 minute)						
Open Contacts	kV	3	2.5	2.5		
Between Contacts and Coil	kV	5	2.5	2.5		
Insulation Resistance @ 500 VDC	Ω	>3G	>3G	>3G		
COILS (Ohms ±10% @ 20°C)		200-GP2C06** / 200-GP2X06**				
VOLTAGE		Coil Resistance (+/- 10% OHMS)	Power Consumption	Pick-Up Voltage	Drop-Out Voltage	Maximum Allowed Voltage
12V AC		80	1.1 VA	≤85% of Nominal Voltage	≥ 30% of Nominal Voltage	110% of Rated Voltage
24V AC		290				
48V AC		1,200				
115V AC		7,300				
230V AC		28,800				
12V DC		224	0.7 W	≤75% of Nominal Voltage	≥ 10% of Nominal Voltage	110% of Rated Voltage
24V DC		742				
48V DC		3,500				
110V DC		19,900				
COILS (Ohms ±10% @ 20°C)		200-GP2C10** / 200-GP2X10** / 200-GP2XY10**				
VOLTAGE		Coil Resistance (+/- 10% OHMS)	Power Consumption	Pick-Up Voltage	Drop-Out Voltage	Maximum Allowed Voltage
6V AC		12	1.2 VA	≤85% of Nominal Voltage	≥ 30% of Nominal Voltage	110% of Rated Voltage
12V AC		50				
24V AC		190				
48V AC		785				
110 / 115V AC		3,880				
230V AC		17,400				
12V DC		160	1.0 W	≤75% of Nominal Voltage	≤10% of Nominal Voltage	110% of Rated Voltage
24V DC		640				
48V DC		2,600				
110V DC		13,600				
220V DC		54,000				
ENVIRONMENTAL						
Operate Time + Bounce Time	ms	10	10	16		
Release Time + Bounce Time	ms	8	8	8		
Ambient Temperature		-40°C to +70°C (-40°F to +158°F)	-40°C to +70°C (-40°F to +158°F)	-40°C to +70°C (-40°F to +158°F)		
Mechanical Life Operations		10 Million AC, 20 Million DC Relays	10 Million AC, 20 Million DC Relays	10 Million AC, 20 Million DC Relays		
Electrical Life @ Nominal Load	ops	>100,000	>100,000	>100,000		
Operating Frequency @ Nominal Load		1,200/hour	1,200/hour	1,200/hour		
Protection		IP40 / RT1	IP40 / RT1	IP40 / RT1		
Weight	gms	21	43	43		
ROHS COMPLIANCE		For RoHS compliance documentation by product, refer to c3controls.com				

SQUARE BASE 4 POLE RELAYS WITH BLADE TERMINALS

- 4PDT relays with a 6-amp rating offer flexibility for control circuit applications.
- Coil voltages printed on top of relays for easy identification, ensuring the right choice for your application.
- Our color-coded push buttons simplify operation by clearly distinguishing between DC (blue) and AC (red) controls.
- Comprehensive selection of coil voltages, ranging from 6V to 230V AC and 12V to 220V DC.
- Low coil consumption to minimize transformer and power supply requirements.
- Transparent housing designed for visual observation of switching mechanisms and contact points, allowing for real-time assessment of operational and wear status.
- Small size requiring minimum panel space for lower installed cost.
- Schematic diagram and terminal markings on the relay for easy reference during installation.
- Optional manual and lockable push button and LED indicator for checking the control circuit operation without energizing the relay and to easily determine the relay status.
- 100% tested to ensure performance to specification.
- UL, CSA and CE for acceptance in global applications.
- AgNi contacts, environmentally friendly - cadmium-free.

IT'S EASY TO BUILD YOUR OWN RELAY

Simply pick the code number from each of the sections below and combine them to build your part number.

Square Base 4 Pole Relay with Blade Terminals

200-GP 4C 06 |
I II III IV V

Example: To build one of our most popular Relays, the part number would be **200-GP + 4C + 06 + IV + V** or **200-GP4C06LPC**

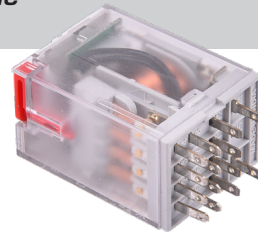

I. RELAY TYPE

CODE	DESCRIPTION
200-GP	General Purpose Relay

II. POLES / CONTACT TYPE

CODE	DESCRIPTION	LIST
4C	4PDT (4 C/O)	\$11.20

III. CURRENT RATING

CODE	DESCRIPTION
06	6 Amps

IV. OPTIONS

CODE	DESCRIPTION	LIST
(Blank)	No Options	—
LP	LED Indicator, Manual and Lockable Push Button	\$ 2.00
LPW	LED Indicator, Manual and Lockable Push Button with Free Wheeling Diode*	\$10.00
LPG	LED Indicator, Manual and Lockable Push Button with Free Wheeling Diode and Polarity Diode*	\$12.00
LPR	LED Indicator, Manual and Lockable Push Button with RC Circuit*	\$16.00
LPH	LED Indicator, Manual and Lockable Push Button with Bridge Rectifier*	\$12.00

V. COIL VOLTAGE

CODE	DESCRIPTION	FOR OPTION CODES
A	6V AC*	LP
B	12V AC*	LP
C	24V AC	LP, LPH
J	48V AC*	LP, LPH
I	110V AC*	LP
U	115V AC	LP, LPR
V	230V AC	LP, LPR
ZB	12V DC*	LP, LPW, LPG
ZC	24V DC	LP, LPW, LPG, LPH
ZJ	48V DC*	LP, LPW, LPG, LPH
ZD	110V DC	LP, LPW, LPG
ZE	220V DC*	LP, LPW, LPG

*NOTE: Products marked with * are not available for same-day shipping. Please contact our Customer First Team for lead times and minimum order quantities.



COMPATIBLE SOCKETS

RELAY TYPE	COMPATIBLE SOCKETS
200-GP4C06**	200-SB1406O with Screw Clamp Terminals (Guarded) or 200-SB1406B* with Box Terminals

NOTE: ** Represents the Options and Coil Voltage codes. Refer to charts IV & V above. See page 15 for socket information.

SPECIFICATIONS:

SQUARE BASE 4 POLE RELAYS						
		200-GP4C06**				
CONTACTS						
Maximum Switching Current	A	6				
Maximum Peak Inrush Current (20ms)	A	15				
Maximum Switching Voltage	V	250				
Maximum AC Load	kVA	2.5				
Resistive Load	PF = 1.0	250 VAC - 6A 30 VDC - 6A				
Inductive Load	PF = 0.4 (L/R = 7 mSec)	120 VAC - 3A 28 VDC - 3A				
Minimum Recommended Load		10 VDC - 10mA				
INSULATION						
Dielectric Strength (1 minute)						
Between Adjacent Poles	kV	2.5				
Between Contacts and Coil	kV	2.5				
Insulation Resistance @ 500 VDC	Ω	3G				
COILS (Ohms ±10% @ 20°C)						
VOLTAGE		Coil Resistance (+/- 10% OHMS)	Power Consumption	Pick-Up Voltage	Drop-Out Voltage	Maximum Allowed Voltage
6V AC		3.15	1.2 VA	≤85% of Nominal Voltage	≥ 30% of Nominal Voltage	110% of Rated Voltage
12V AC		13.3				
24V AC		52				
48V AC		240				
110 / 115V AC		1,120				
230V AC		5,600	1.0 W	≤75% of Nominal Voltage	≥ 10% of Nominal Voltage	110% of Rated Voltage
12V DC		115				
24V DC		480				
48V DC		1,850				
110V DC		9,000				
220V DC		29,000				
ENVIRONMENTAL						
Operate Time + Bounce Time	ms	10				
Release Time + Bounce Time	ms	6				
Ambient Temperature		-40°C to +70°C (-40°F to +158°F)				
Mechanical Life Operations		10 Million AC, 20 Million DC Relays				
Electrical Life @ Nominal Load	ops	>100,000				
Operating Frequency @ Nominal Load		1,200/hour				
Protection		IP40				
Weight	gms	80				
ROHS COMPLIANCE						
For RoHS compliance documentation by product, refer to c3controls.com						

OCTAL BASE 2 POLE RELAYS WITH PIN TERMINALS

- DPDT and DPST relays for control circuit application flexibility.
- Pin terminals allow for universal socket fit and are interchangeable with other commonly available octal base relays.
- Coil voltages printed on top of relays for easy identification, ensuring the right choice for your application.
- Our color-coded push buttons simplify operation by clearly distinguishing between DC (blue) and AC (red) controls.
- Comprehensive selection of coil voltages, ranging from 12V to 230V AC and 6V to 220V DC.
- Low coil consumption to minimize transformer and power supply requirements.
- Transparent housing designed for visual observation of switching mechanisms and contact points, allowing for real-time assessment of operational and wear status.
- Small size requiring minimum panel space for lower installed cost.
- Schematic diagram and terminal markings on the relay for easy reference during installation.
- Optional manual and lockable push button and LED indicator for checking the control circuit operation without energizing the relay and to easily determine the relay status.
- 100% tested to ensure performance to specification.
- UL, CSA and CE for acceptance in global applications.
- AgNi contacts, environmentally friendly - cadmium-free.

IT'S EASY TO BUILD YOUR OWN RELAY

Simply pick the code number from each of the sections below and combine them to build your part number.

Octal Base 2 Pole Relays with Pin Terminals

210-GP **10**
 I II III IV V

Example: To build one of our most popular Relays, the part number would be **210-GP + II + 10 + IV + V** or **210-GP2C10LPC**

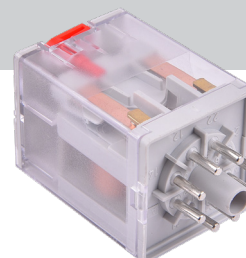

I. RELAY TYPE

CODE	DESCRIPTION
210-GP	General Purpose Relay

II. POLES / CONTACT TYPE

CODE	DESCRIPTION	LIST
2X	DPST (2 N.O.)*	\$24.00
2C	DPDT (2 C/O)	\$14.00
2XY	DPST (1 N.O. + 1 N.C.)*	\$20.00
2XD	SPST (1 N.O., Double Break)*	\$20.00

III. CURRENT RATING

CODE	DESCRIPTION
10	10 Amps

IV. OPTIONS

CODE	DESCRIPTION	LIST
(Blank)	No Options	—
LP	LED Indicator, Manual and Lockable Push Button	\$ 2.00
LPG	LED Indicator, Manual and Lockable Push Button with Free Wheeling Diode and Polarity Diode*	\$12.00
LPR	LED Indicator, Manual and Lockable Push Button with RC Circuit*	\$16.00
LPH	LED Indicator, Manual and Lockable Push Button with Bridge Rectifier*	\$12.00

V. COIL VOLTAGE

CODE	DESCRIPTION	FOR OPTION CODES
B	12V AC*	LP
C	24V AC	LP, LPH
J	48V AC*	LP, LPH
I	110V AC	LP
V	230V AC	LP, LPR
ZB	12V DC*	LP, LPG
ZC	24V DC	LP, LPG, LPH
ZJ	48V DC*	LP, LPG, LPH
ZD	110V DC	LP, LPG
ZE	220V DC*	LP, LPG

*NOTE: Products marked with * are not available for same-day shipping. Please contact our Customer First Team for lead times and minimum order quantities.



COMPATIBLE SOCKETS

RELAY TYPE	COMPATIBLE SOCKETS
210-GP2C10**	210-SP0810B with Box Terminals
210-GP2X10**	
210-GP2XY10**	
210-GP2XD10**	

NOTE: ** Represents the Options and Coil Voltage codes. Refer to charts IV & V above. See page 16 for socket information.

SPECIFICATIONS:

OCTAL BASE 2 POLE RELAYS						
	UNITS	210-6P2C10**	210-6P2X10**	210-6P2XY10**/ 210-6P2XD10**		
CONTACTS						
Maximum Switching Current	A	10				
Maximum Peak Inrush Current (20ms)	A	30				
Maximum Switching Voltage	V	250				
Maximum AC Load	kVA	2.5				
Resistive Load	PF = 1.0	250 VAC - 10A 30 VDC - 10A				
Inductive Load	PF = 0.4 (L/R = 7 mSec)	240 VAC - 7A 120 VAC - 10A 28 VDC - 8A				
Motor Load		240 VAC - 1/3 HP 120 VAC - 1/4 HP				
Minimum Recommended Load		10 VDC - 10mA				
INSULATION						
Dielectric Strength (1 minute)						
Between Adjacent Poles	kV	1.5	2			
Between Contacts and Coil	kV	2	2.5			
Insulation Resistance @ 500 VDC	Ω	200M				
COILS (Ohms ±10% @ 20°C)						
VOLTAGE		Coil Resistance (+/- 10% OHMS)	Power Consumption	Pick-Up Voltage	Drop-Out Voltage	Maximum Allowed Voltage
12V AC		13.3	2.5 VA	≤85% of Nominal Voltage	≥ 30% of Nominal Voltage	110% of Rated Voltage
24V AC		52				
48V AC		240				
110V AC		1,120				
230V AC		5,600				
12V DC		115	0.7 W	≤75% of Nominal Voltage	≥ 10% of Nominal Voltage	110% of Rated Voltage
24V DC		480				
48V DC		1,850				
110V DC		9,000				
220V DC		29,000				
ENVIRONMENTAL						
Operate Time + Bounce Time	ms	8+3/3.5+8				
Release Time + Bounce Time	ms	9+8/12+16	20+3			
Ambient Temperature		-40°C to +70°C (-40°F to +158°F) 20+8				
Mechanical Life Operations		10 Million AC, 20 Million DC Relays				
Electrical Life @ Nominal Load	ops	>100,000				
Operating Frequency @ Nominal Load		1,200/hour				
Protection		IP40				
Weight	gms	80				
ROHS COMPLIANCE		For RoHS compliance documentation by product, refer to c3controls.com				

OCTAL BASE 3 POLE RELAYS WITH PIN TERMINALS

- 3PDT and 3PST relays for control circuit application flexibility.
- Pin terminals allow for universal socket fit and are interchangeable with other commonly available octal base relays.
- Coil voltages printed on top of relays for easy identification, ensuring the right choice for your application.
- Our color-coded push buttons simplify operation by clearly distinguishing between DC (blue) and AC (red) controls.
- Comprehensive selection of coil voltages, ranging from 12V to 230V AC and 6V to 220V DC.
- Low coil consumption to minimize transformer and power supply requirements.
- Transparent housing designed for visual observation of switching mechanisms and contact points, allowing for real-time assessment of operational and wear status.
- Small size requiring minimum panel space for lower installed cost.
- Schematic diagram and terminal markings on the relay for easy reference during installation.
- Optional manual and lockable push button and LED indicator for checking the control circuit operation without energizing the relay and to easily determine the relay status.
- 100% tested to ensure performance to specification.
- UL, CSA and CE for acceptance in global applications.
- AgNi contacts, environmentally friendly - cadmium-free.

IT'S EASY TO BUILD YOUR OWN RELAY

Simply pick the code number from each of the sections below and combine them to build your part number.

Octal Base 3 Pole Relays with Pin Terminals

210-GP **10**
 I II III IV V

Example: To build one of our most popular Relays, the part number would be **210-GP + II + 10 + IV + V** or **210-GP3C10C**



I. RELAY TYPE

CODE	DESCRIPTION
210-GP	General Purpose Relay

II. POLES / CONTACT TYPE

CODE	DESCRIPTION	LIST
3X	3PST (3 N.O.)*	\$25.00
3C	3PDT (3 C/O)	\$15.60

III. CURRENT RATING

CODE	DESCRIPTION
10	10 Amps

IV. OPTIONS

CODE	DESCRIPTION	LIST
(Blank)	No Options	—
LP	LED Indicator, Manual and Lockable Push Button	\$ 2.00
LPW	LED Indicator, Manual and Lockable Push Button with Free Wheeling Diode*	\$10.00
LPG	LED Indicator, Manual and Lockable Push Button with Free Wheeling Diode and Polarity Diode*	\$12.00
LPR	LED Indicator, Manual and Lockable Push Button with RC Circuit*	\$16.00
LPH	LED Indicator, Manual and Lockable Push Button with Bridge Rectifier*	\$12.00

V. COIL VOLTAGE

CODE	DESCRIPTION	FOR OPTION CODES
B	12V AC*	LP
C	24V AC	LP, LPH
J	48V AC*	LP, LPH
I	110V AC	LP
V	230V AC	LP, LPR
ZB	12V DC*	LP, LPW, LPG
ZC	24V DC	LP, LPW, LPG, LPH
ZJ	48V DC*	LP, LPW, LPG, LPH
ZD	110V DC	LP, LPW, LPG
ZE	220V DC*	LP, LPW, LPG

*NOTE: Products marked with * are not available for same-day shipping. Please contact our Customer First Team for lead times and minimum order quantities.



COMPATIBLE SOCKETS

RELAY TYPE	COMPATIBLE SOCKETS
210-GP3C10**	210-SP1110B with Box Terminals
210-GP3X10**	

NOTE: ** Represents the Options and Coil Voltage codes. Refer to charts IV & V above. See page 16 for socket information.

SPECIFICATIONS:

OCTAL BASE 3 POLES RELAYS						
	UNITS	210-6P3C10**/ 210-6P3X10**				
CONTACTS						
Maximum Switching Current	A	10				
Maximum Peak Inrush Current (20ms)	A	30				
Maximum Switching Voltage	V	250				
Maximum AC Load	kVA	2.5				
Resistive Load	PF = 1.0	250 VAC - 10A 30 VDC - 10A				
Inductive Load	PF = 0.4 (L/R = 7 mSec)	240 VAC - 7A 120 VAC - 10A 28 VDC - 8A				
Motor Load		240 VAC - 1/3 HP 120 VAC - 1/4 HP				
Minimum Recommended Load		10 VDC - 10mA				
INSULATION						
Dielectric Strength (1 minute)						
Between Adjacent Poles	kV	2				
Between Contacts and Coil	kV	2.5				
Insulation Resistance @ 500 VDC	Ω	200M				
COILS (Ohms ±10% @ 20°C)						
VOLTAGE		Coil Resistance (+/- 10% OHMS)	Power Consumption	Pick-Up Voltage	Drop-Out Voltage	Maximum Allowed Voltage
12V AC		13.3	2.5 VA	≤85% of Nominal voltage	≥ 30% of Nominal voltage	110% of Rated Voltage
24V AC		52				
48V AC		240				
110 / 115V AC		1,120				
230V AC		5,600	0.7 W	≤75% of Nominal Voltage	≥ 10% of Nominal Voltage	110% of Rated Voltage
12V DC		115				
24V DC		480				
48V DC		1,850				
110V DC		9,000				
220V DC		29,000				
ENVIRONMENTAL						
Operate Time + Bounce Time	ms	8+3/3.5+8				
Release Time + Bounce Time	ms	9+8/12+16				
Ambient Temperature		-40°C to +70°C (-40°F to +158°F)				
Mechanical Life Operations		10 Million AC, 20 Million DC Relays				
Electrical Life @ Nominal Load	ops	>100,000				
Operating Frequency @ Nominal Load		1,200/hour				
Protection		IP40				
Weight	gms	80				
ROHS COMPLIANCE		For RoHS compliance documentation by product, refer to c3controls.com				

GENERAL PURPOSE PIN & BLADE RELAY SOCKETS

- DIN rail mounting for fast and easy installation.
- IP20 guarded terminals to prevent accidental contact with live parts.
- Combination head (+/-) terminal screws accept straight, phillips, or pozidrive screwdrivers.
- UL, CSA and CE for acceptance in global applications.
- Open style terminals to accept ring tongue terminals.
- Panel mounting for secure installation in high vibration and shock installations.

5 & 8 BLADE OPEN & BOX TYPE SOCKETS

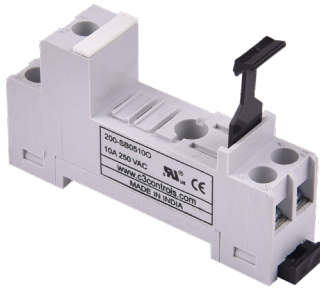

5 BLADE SOCKETS FOR SQUARE BASE 1 POLE RELAYS, 10A

CODE	DESCRIPTION	LIST
200-SB05100	5 Blade 10 Amp Screw Clamp Terminals (Guarded)	\$ 6.00
200-SB0510B	5 Blade 10 Amp Box Terminal*	\$ 6.00

*NOTE: Not available for same-day shipping. Please contact our Customer First Team for lead times and minimum order quantities.

SPECIFICATIONS:

Nominal Load:	10A /250 V
Insulation:	Di-electric strength, 1 minute
Between Contact and Coil:	5 kV
Between All Terminals and DIN Rail:	5 kV
Between Adjacent Terminals:	3 kV

Brass Tin Plated Screw:

Maximum Screw Torque:	1.2 Nm
Screw Dimensions:	M3, Pozi

Wire In Lets Capacity:

Solid Wire:	4mm ² or 2x2.25mm ²
Multi Core:	22-14 AWG
Ferrule Tip Terminals:	4mm ²
Weight Approximately:	28 gms

ROHS COMPLIANCE: For documentation by product, refer to c3controls.com.

FOR USE WITH:

RELAY: 200-GP1C10** & 200-GP1X10**

NOTE: **Represents the Options and Coil Voltage Codes. Refer to page 4 for codes.

8 BLADE SOCKETS FOR SQUARE BASE 2 POLE RELAYS, 6A

CODE	DESCRIPTION	LIST
200-SB08060	8 Blade 6 Amp Screw Clamp Terminals (Guarded)	\$ 6.00
200-SB0806B	8 Blade 6 Amp Box Terminal*	\$ 6.00

*NOTE: Not available for same-day shipping. Please contact our Customer First Team for lead times and minimum order quantities.

SPECIFICATIONS:

Nominal Load:	6A @ 250 V
Insulation:	Di-electric strength, 1 minute
Between Contact and Coil:	5 kV
Between All Terminals and DIN Rail:	5 kV
Between Adjacent Terminals:	3 kV

Brass Tin Plated Screw:

Maximum Screw Torque:	1.2 Nm
Screw Dimensions:	M3, Pozi

Wire In Lets Capacity:

Solid Wire:	4mm ² or 2x2.25mm ²
Multi Core:	22-14 AWG
Ferrule Tip Terminals:	4mm ²
Weight Approximately:	38 gms

ROHS COMPLIANCE: For documentation by product, refer to c3controls.com.

FOR USE WITH:

RELAY: 200-GP2C06** & 200-GP2X06**

NOTE: **Represents the Options and Coil Voltage Codes. Refer to page 6 for codes.



8 & 14 BLADE OPEN & BOX TYPE SOCKETS



GENERAL PURPOSE RELAYS

8 BLADE SOCKETS FOR SQUARE BASE 2 POLE RELAYS, 10A

CODE	DESCRIPTION	LIST
200-SB08100	8 Blade 10 Amp Screw Clamp Terminals (Guarded)	\$ 6.00
200-SB0810B	8 Blade 10 Amp Box Terminal*	\$ 6.00

*NOTE: Not available for same-day shipping. Please contact our Customer First Team for lead times and minimum order quantities

SPECIFICATIONS:	
Nominal Load:	12A @ 250 V
Insulation:	Di-electric strength, 1 minute
Between Contact and Coil:	2.5 kV
Between All Terminals and DIN Rail:	2.5 kV
Between Adjacent Terminals:	2.5 kV
Brass Tin Plated Screw:	
Maximum Screw Torque:	1.2 Nm
Screw Dimensions:	M3, Pozi
Wire In Lets Capacity:	
Solid Wire:	4mm ² or 2x2.25mm ²
Multi Core:	22-14 AWG
Ferrule Tip Terminals:	4mm ²
Weight Approximately:	61 gms
ROHS COMPLIANCE: For documentation by product, refer to c3controls.com.	
FOR USE WITH:	
RELAY: 200-GP2X10**, 200-GP2C10** & 200-GP2XY10**	
NOTE: **Represents the Options and Coil Voltage Codes. Refer to page 6 for codes.	

14 BLADE SOCKETS FOR SQUARE BASE 4 POLE RELAYS, 6A

CODE	DESCRIPTION	LIST
200-SB14060	14 Blade 6 Amp Screw Clamp Terminals (Guarded)	\$ 9.00
200-SB1406B	14 Blade 6 Amp Box Terminal*	\$ 9.00

*NOTE: Not available for same-day shipping. Please contact our Customer First Team for lead times and minimum order quantities

SPECIFICATIONS:	
Nominal Load:	7A @ 250 V
Insulation:	Di-electric strength, 1 minute
Between Contact and Coil:	2.5 kV
Between All Terminals and DIN Rail:	2.5 kV
Between Adjacent Terminals:	2.5 kV
Brass Tin Plated Screw:	
Maximum Screw Torque:	1.2 Nm
Screw Dimensions:	M3, Pozi
Wire In Lets Capacity:	
Solid Wire:	4mm ² or 2x2.25mm ²
Multi Core:	22-14 AWG
Ferrule Tip Terminals:	4mm ²
Weight Approximately:	54 gms
ROHS COMPLIANCE: For documentation by product, refer to c3controls.com.	
FOR USE WITH:	
RELAY: 200-GP4C06**	
NOTE: **Represents the Options and Coil Voltage Codes. Refer to page 8 for codes.	



8 & 11 PIN BOX TYPE SOCKETS



8 PIN SOCKET FOR OCTAL BASE 2 POLE RELAYS, 10A

CODE	DESCRIPTION	LIST
210-SP0810B	8 Pin 10 Amp Box Terminal	\$ 6.00

SPECIFICATIONS:	
Nominal Load:	10A @ 250 V
Insulation:	Di-electric strength, 1 minute
Between Contact and Coil:	2.5 kV
Between All Terminals and DIN Rail:	2.5 kV
Between Adjacent Terminals:	2.5 kV
Brass Tin Plated Screw:	
Maximum Screw Torque:	0.5 Nm
Screw Dimensions:	M3, Pozi
Wire In Lets Capacity:	
Solid Wire:	4mm ² or 2x2.25mm ²
Multi Core:	22-14 AWG
Ferrule Tip Terminals:	4mm ²
Weight Approximately:	47 gms
ROHS COMPLIANCE: For documentation by product, refer to c3controls.com.	

FOR USE WITH:
 RELAY: 210-GP2X10**, 210-GP2C10**, 210-GP2XY10** & 210-GP2XD10**
 NOTE: **Represents the Options and Coil Voltage Codes. Refer to page 10 for codes.

11 PIN SOCKET FOR OCTAL BASE 3 POLE RELAYS, 10A

CODE	DESCRIPTION	LIST
210-SP1110B	11 Pin 10 Amp Box Terminal	\$ 6.00

SPECIFICATIONS:	
Nominal Load:	10A @ 250 V
Insulation:	Di-electric strength, 1 minute
Between Contact and Coil:	2.5 kV
Between All Terminals and DIN Rail:	2.5 kV
Between Adjacent Terminals:	2.5 kV
Brass Tin Plated Screw:	
Maximum Screw Torque:	0.5 Nm
Screw Dimensions:	M3, Pozi
Wire In Lets Capacity:	
Solid Wire:	4mm ² or 2x2.25mm ²
Multi Core:	22-14 AWG
Ferrule Tip Terminals:	4mm ²
Weight Approximately:	47 gms
ROHS COMPLIANCE: For documentation by product, refer to c3controls.com.	

FOR USE WITH:
 RELAY: 210-GP3X10** & 210-GP3C10**
 NOTE: **Represents the Options and Coil Voltage Codes. Refer to page 12 for codes.



SQUARE BASE W/BLADE TERMINALS - 1 POLE (200-GP1C10 & 200-GP1X10**)**

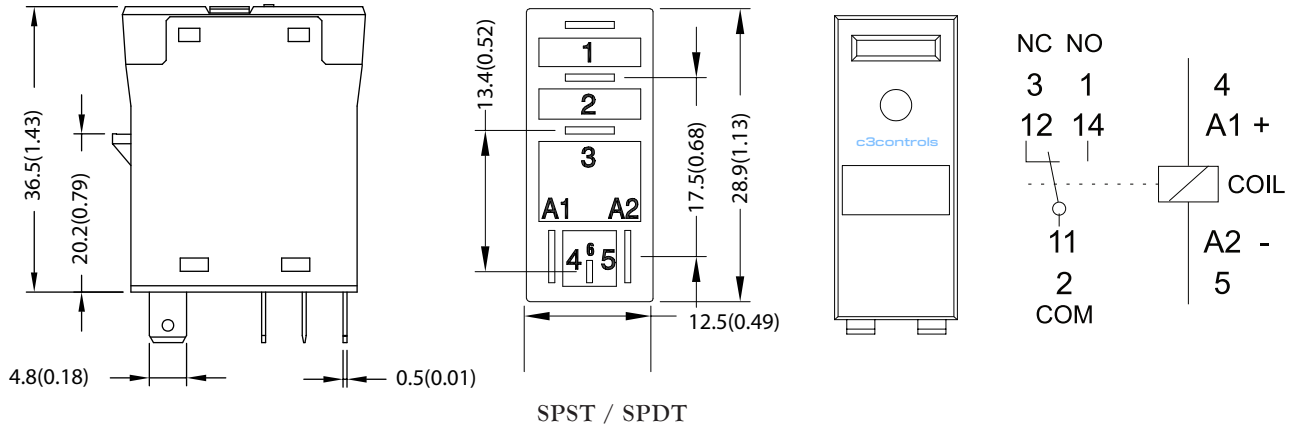

SQUARE BASE W/BLADE TERMINALS - 2 POLES (200-GP2C06 & 200-GP2X06**)**

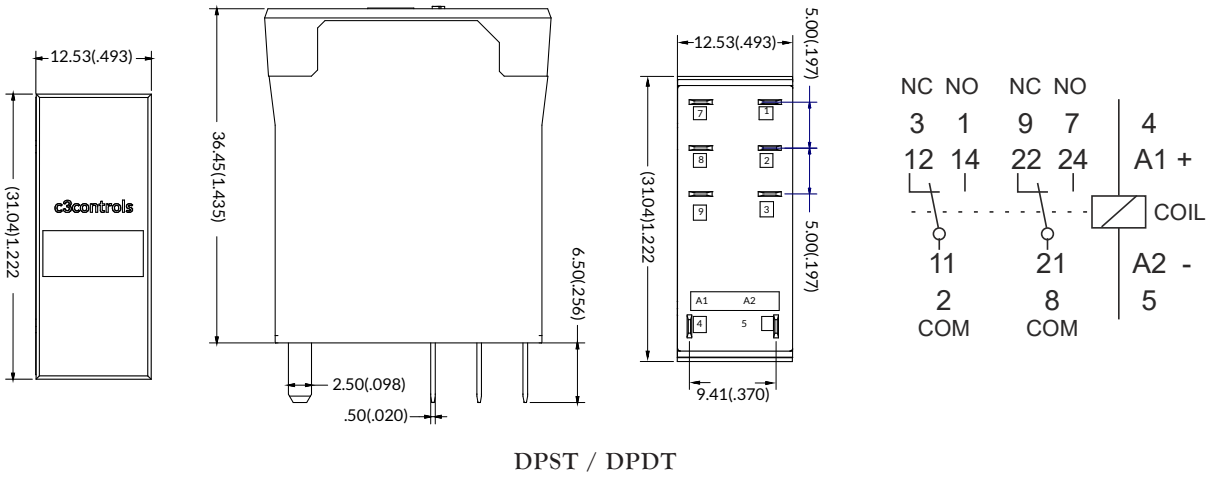

SQUARE BASE W/BLADE TERMINALS - 2 POLES (200-GP2C10, 200-GP2X10** & 200-GP2XY10**)**

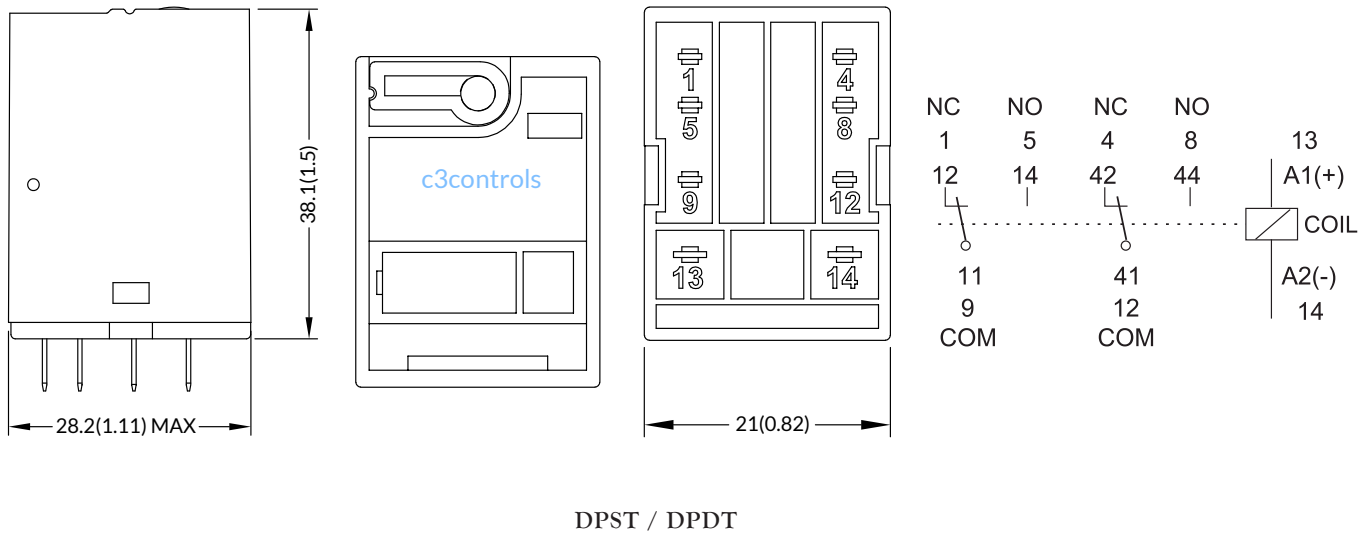

SQUARE BASE W/BLADE TERMINALS - 4 POLES (200-GP4C06)**

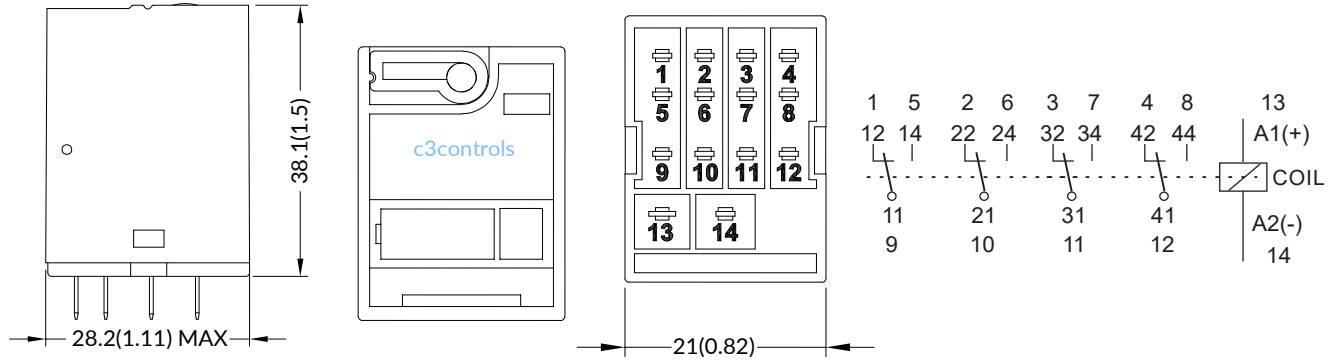

4PDT

OCTAL BASE W/PIN TERMINALS - 2 POLES (210-GP2C10, 210-GP2X10**, 210-GP2XY10** & 210-GP2XD10**)**

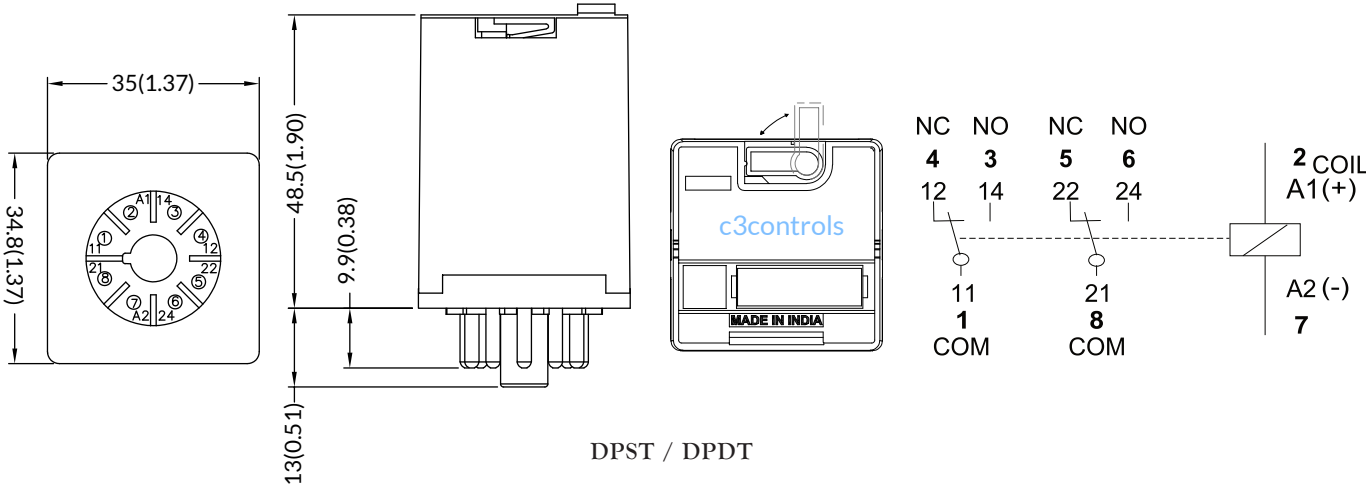

DPST / DPDT

OCTAL BASE W/PIN TERMINALS - 3 POLES (210-GP3C10 & 210-GP3X10**)**

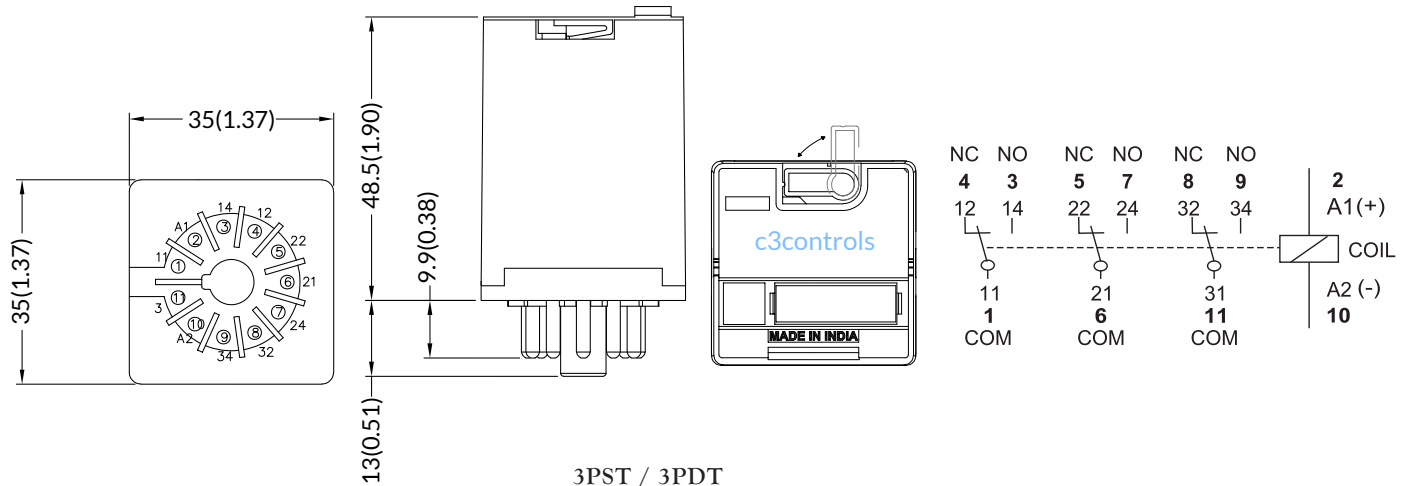

3PST / 3PDT

5 BLADE SOCKETS FOR SQUARE BASE RELAYS, 10A (200-SB05100 & 200-SB0510B)

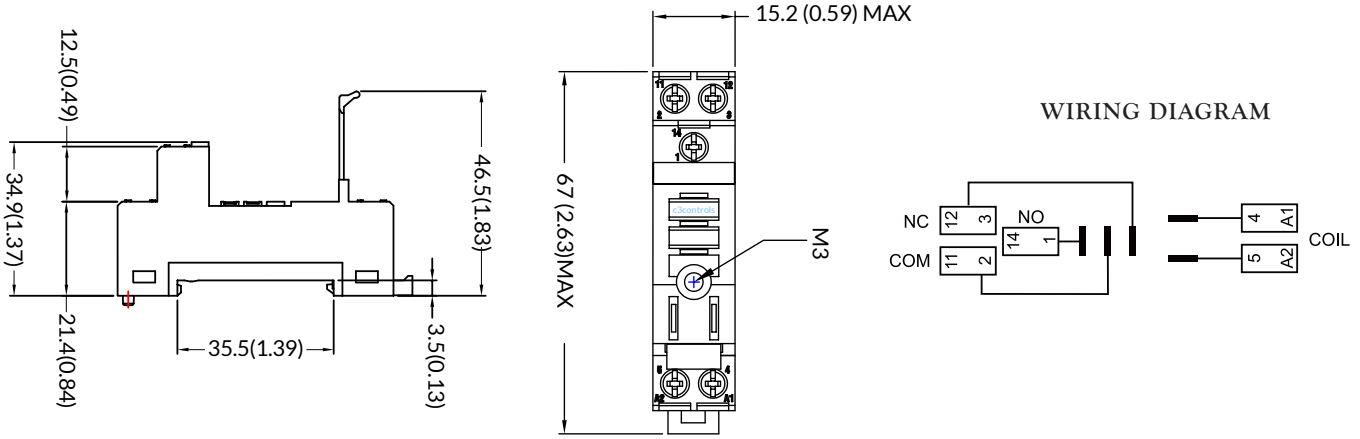

8 BLADE SOCKETS FOR SQUARE BASE RELAYS, 6A (200-SB08060 & 200-SB0806B)

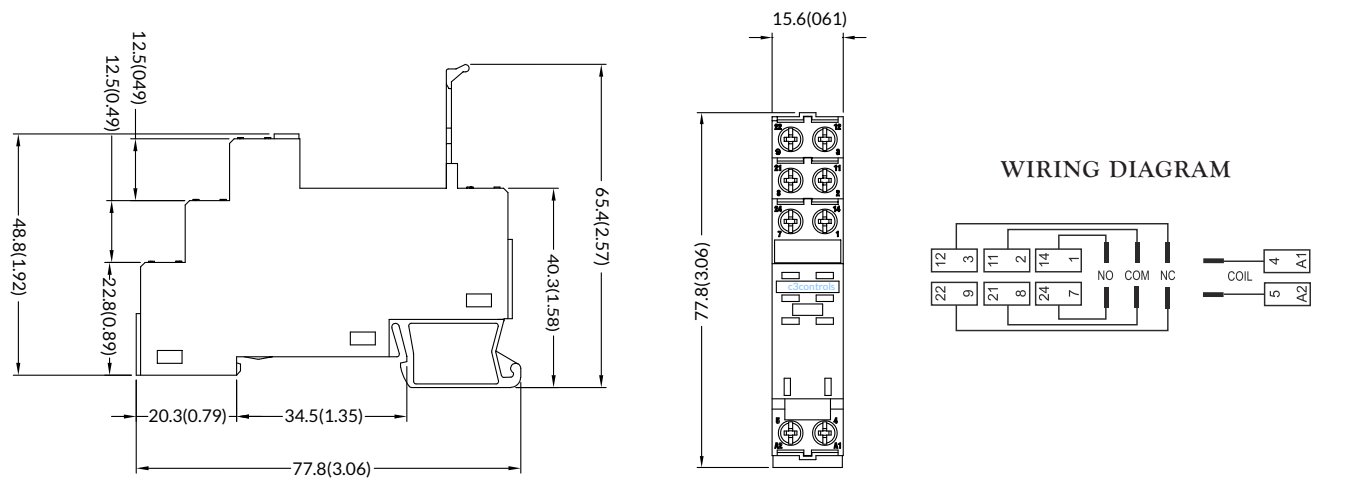

8 BLADE SOCKETS FOR SQUARE BASE RELAYS, 10A (200-SB08100 & 200-SB0810B)

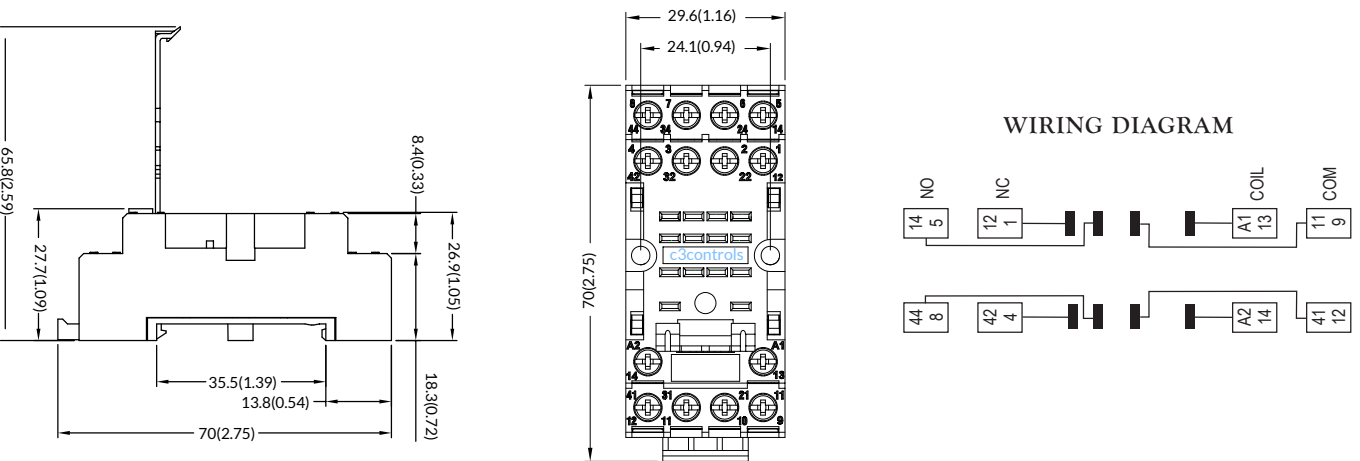

14 BLADE SOCKETS FOR SQUARE BASE RELAYS, 6A (200-SB14060 & 200-SB1406B)

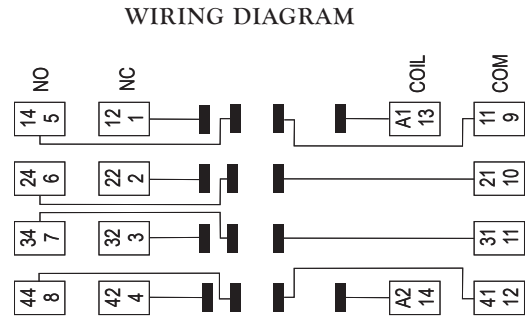
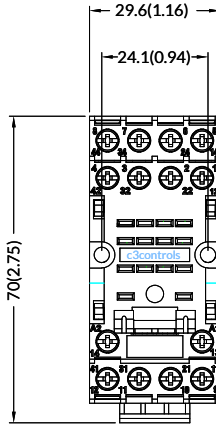
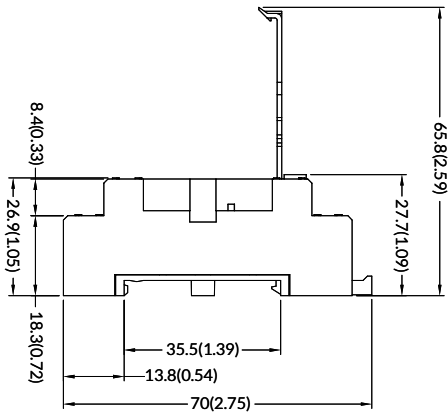

8 PIN SOCKET FOR OCTAL BASE RELAYS, 10A (210-SP0810B)

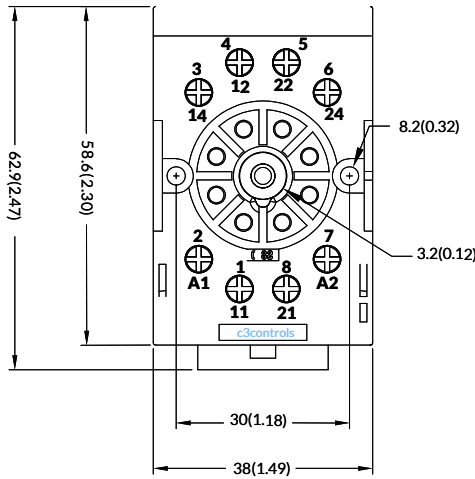
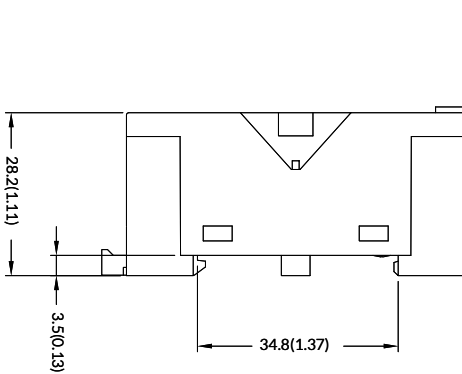

WIRING DIAGRAM

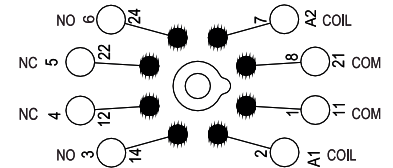

11 PIN SOCKET FOR OCTAL BASE RELAYS, 10A (210-SP1110B)

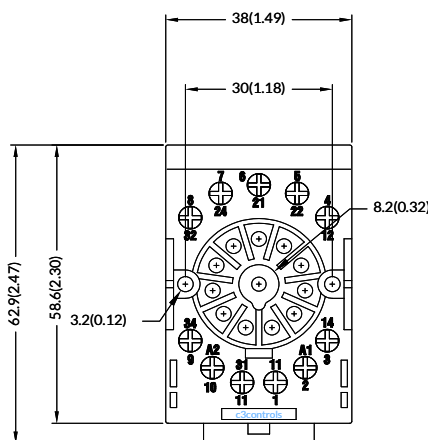
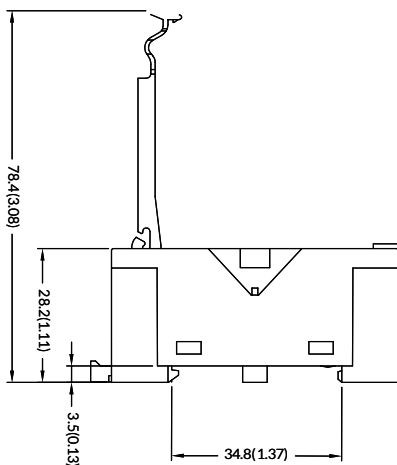

WIRING DIAGRAM

