

30MM INDUSTRIAL PILOT DEVICES



c3controls' 30mm Industrial Pilot Devices offer superior quality at an affordable price. These modular devices feature a rugged, all-polyester construction, are UL listed and are rated Type 4/4X as standard for watertight and corrosion resistance. c3's pilot devices are also listed for Type 1, 2, 3, 3R, 12 and 13 requirements.



Section 13

Contact Blocks	4
Push Buttons	6
Special Operators	17
Pilot Lights	20
Selector Switches	26
Legend Plates	30
Accessories	32
Specifications	34
Dimensions	36

PROVEN



Conformity to Standards:

PILOT DEVICES

UL 508, 1604

CSA C22.2 No. 14, 213

IEC 60947-1, 60947-5-1



MULTI-VOLTAGE PILOT LIGHTS

UL 508, 1604

IEC 60947-1, 60947-5-1

Certifications:

UL File #: E68568 (Guide NKCR, NKCR7), E157436 (Guide NOIV)

CSA File #: LR47446

CE Marked (per EU Low Voltage Directive 2006/95/EC and RoHS Directive 2011/65/EU)

UL File #: E68568 (Guide NKCR, NKCR7), E157436 (Guide NOIV)

CE Marked (per EU Low Voltage Directive 2006/95/EC and RoHS Directive 2011/65/EU)

Visit www.c3controls.com to download product certifications.

30MM INDUSTRIAL PILOT DEVICES

All our products are fully certified, rated, and backed by our limited lifetime warranty to meet the needs of the machine builder, and our 30mm Industrial Pilot Devices are no exception. Check out the incredible features in the chart below!

DELIVERING SUPERIOR PRODUCT QUALITY AND MANUFACTURING EXCELLENCE	
✓ Proven	Our 30mm industrial operators are UL Listed, CSA Certified and CE marked meeting global standards requirements. 
✓ Easy to Install	Our “snap-on” contact blocks are color coded for quick circuit identification and feature 35° angled captive terminal screws and self-lifting pressure plates for fast and easy wiring.
✓ Simple Customization	Our light modules come with various lens color options for appropriate operator interface and are available in incandescent, neon, or our LED lamps with leakage protection.
✓ Rugged Design	Optional polyester or polished aluminum clamp rings with coarse 16 pitch threads for quick and easy utilization that won’t cross thread or strip.
✓ Visible Certifications	Our product certifications and electrical ratings are clearly marked on the outside of the contact blocks for easy reference during installation.
✓ Heavy Duty	Polyester construction provides superior durability, corrosion resistance, moisture rejection and electrical insulation.
✓ Flexible	Our contact blocks can be stacked 4 deep and up to 2 across for a total of 8 circuits, providing the flexibility to operate multiple control circuits from a single operator.
✓ Convenient	Reduce inventory with our interchangeable modular design, providing endless options for appropriate operator interface.
✓ Environmentally Secure	With 4/4X and IP65 ratings, our 30mm line of pilot devices are built to last and withstand dust, corrosion, ice, and rain.
✓ Limited Lifetime Warranty*	Every product is backed by our limited lifetime warranty—unmatched in the industry—bringing you quality components that perform in the most demanding applications.
✓ Guaranteed Same-Day Shipping*	Product availability reduces inventory, and improves cash-flow—saving you money. With c3controls any order for standard catalog items received by 6:00pm ET is guaranteed to ship same-day.
✓ Advantage Pricing	Our approach to product development, manufacturing, and focus on servicing the OEM and Electrical Equipment Builder reduces cost. The result—the best value in the industry.

*See c3controls Terms & Conditions

“By utilizing the 30mm Multi-Voltage LED Pilot Lights from c3controls, there is no need for us to specify several devices for one job. With one product, we can meet every one of our needs.”

Scott Grinwis, Inside Sales • **Kent Industries**

Momentary Push Button



Emergency Stop



Pilot Light



Selector Switch



UNIQUE PRODUCT LINE FEATURES

METAL ON THE INSIDE

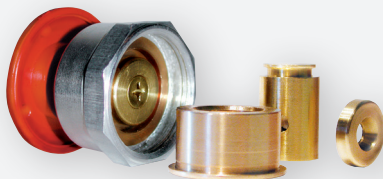

c3controls 30mm Emergency Stop devices contain a solid brass detent mechanism ensuring reliable operation in emergency stop applications, and providing safe interruption of circuits and longer life.

EXCLUSIVE MULTI-VOLTAGE LIGHTS

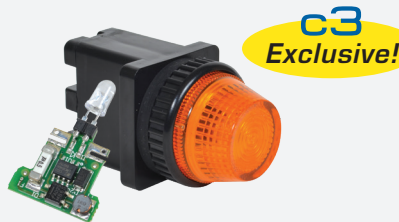

c3controls state-of-the-art multi-voltage light modules—the only U.S. engineered multi-voltage light in the industry!—operate at any voltage from 20V to 277V AC or DC without losing intensity.

U-CUP SEAL

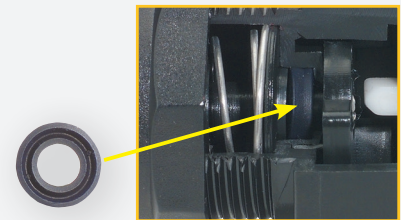

Our revolutionary U-Cup seal is infused with a Teflon coating to eliminate cracking when exposed to harsh conditions and keeps water, oils, and dust away from the contact blocks.

INTERNAL SELF-LUBRICANT

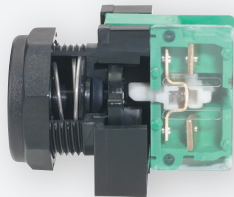

All frictional parts are molded with an internal self-lubricant to provide outstanding wear without troublesome greases used by others.

ONE CAM DESIGN

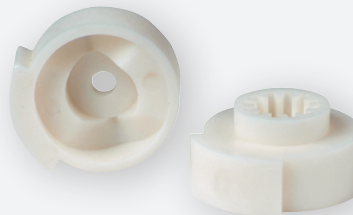

Our single cam design eliminates the need for multiple cam and selector switch configurations, reducing inventory and saves you labor time and costs.

RUBBER BOOTS

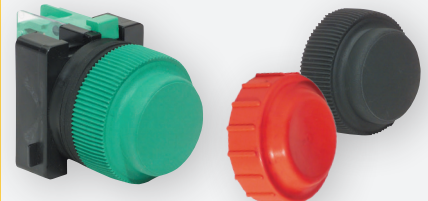

Our state-of-the-art rubber boots are available in both Neoprene and Fluorosilicone, and protect the operators and the circuits behind them from harsh chemicals and climates.

**FIND IT
FAST**

30mm Industrial Pilot Devices



















- Certifications
- Specifications
- Dimension Drawings
- Installation Instructions
- Easy to Buy

www.c3controls.com

SELECT YOUR CONTACT BLOCK

MODULAR CONTACT BLOCK CONFIGURATION

CODE	DESCRIPTION	CONTACT SYMBOL	COLOR	LIST
SILVER CONTACTS				
CBNO	Normally Open Contact Block		Green/Clear	\$13.00
CBNO-IP20	Normally Open Contact Block with IP20 Guarded Terminals		Green/Clear	\$17.00
CBNC	Normally Closed Contact Block		Red/Clear	\$13.00
CBNC-IP20	Normally Closed Contact Block with IP20 Guarded Terminals		Red/Clear	\$17.00
CBEM	Early Make Contact Block		White/Clear	\$17.00
CBEM-IP20	Early Make Contact Block with IP20 Guarded Terminals		White/Clear	\$21.00
CBDB	Delayed Break Contact Block		Black/Clear	\$17.00
CBDB-IP20	Delayed Break Contact Block with IP20 Guarded Terminals		Black/Clear	\$21.00
GOLD PLATED CONTACTS†				
CBNOG	Normally Open Contact Block†		Green/Amber	\$22.00
CBNOG-IP20	Normally Open Contact Block with IP20 Guarded Terminals†		Green/Amber	\$26.00
CBNCG	Normally Closed Contact Block†		Red/Amber	\$22.00
CBNCG-IP20	Normally Closed Contact Block with IP20 Guarded Terminals†		Red/Amber	\$26.00
CBEMG	Early Make Contact Block†		White/Amber	\$26.00
CBEMG-IP20	Early Make Contact Block with IP20 Guarded Terminals†		White/Amber	\$30.00
CBDBG	Delayed Break Contact Block†		Black/Amber	\$26.00
CBDBG-IP20	Delayed Break Contact Block with IP20 Guarded Terminals†		Black/Amber	\$30.00

STANDARD RATING DESIGNATIONS

A600 RATING DESIGNATION

A600 (7,200 VA Make and 720 VA Break),
600V AC Maximum
Maximum Continuous Thermal Current, Ith: 10A

P300 RATING DESIGNATION

P300 (138 VA Make and 138 VA Break),
250V DC Maximum
Maximum Continuous Thermal Current, Ith: 5A

†NOTE: Gold plated contacts are not available for same-day shipping. Contact our Customer First Team for lead times and minimum order quantities.

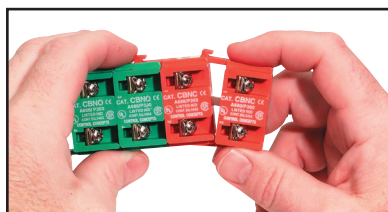

Our Contact Blocks save you time and money by offering the flexibility to operate multiple control circuits from a single pilot device. Most operators can be stacked 4 deep and up to 2 across, providing a total of 8 circuits per operator in any combination. Compared to others, our quick install snap-on feature makes installing multiple blocks a “snap” – they install in less time than it takes to pick up a screwdriver! And our heavy-duty construction ensures that these contact blocks stay connected.



Tired of wiring contact blocks in cramped spaces?

Our unique 35 degree angled terminals provide ease of wiring for quick installation. In fact, you can wire the contact blocks outside the tight space of the control panel, then simply “snap-on” to the operator. All terminal screws have self-lifting captive wire clamps to speed wiring.

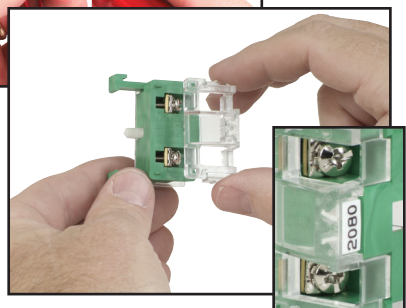

Enhanced safety with field installable IP20 terminal guards

are transparent to maintain terminal visibility. Their construction provides easy access to the device terminals - making wiring fast and convenient, and they snap securely in place without the use of tools. NOTE: IP20 terminal guards must be installed before wiring.

For convenient terminal marking our IP20 terminal guards utilize Series WTB2 markers (see Section 22 Page 32), simplifying wiring and troubleshooting.

30MM STANDARD CONTACT BLOCKS

Our standard contact blocks are stackable 4 deep and up to 2 across on most operators for a total of 8 circuits per operator. They are color coded for instant circuit identification to minimize wiring errors and to expedite the wiring process. You can combine contact block types to achieve your desired function.

Also refer to Section 14 Pages 4 & 5 for our complete selection of Hermetically Sealed and Factory Sealed Contact Blocks in our 30mm H-Line section.

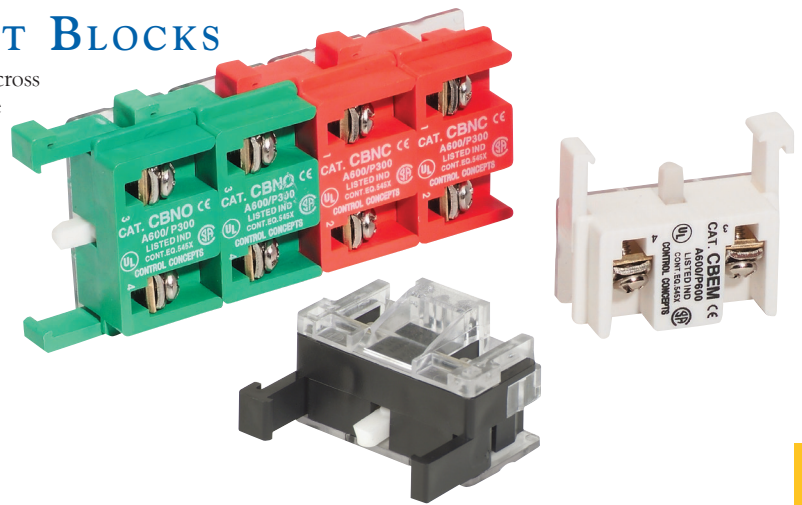

30MM INDUSTRIAL PILOT DEVICES

UNIQUE PRODUCT FEATURES

c3CONTROLS MANUFACTURES THE MOST INNOVATIVE, USER-FRIENDLY LINE OF CONTACT BLOCKS ON THE MARKET TODAY!

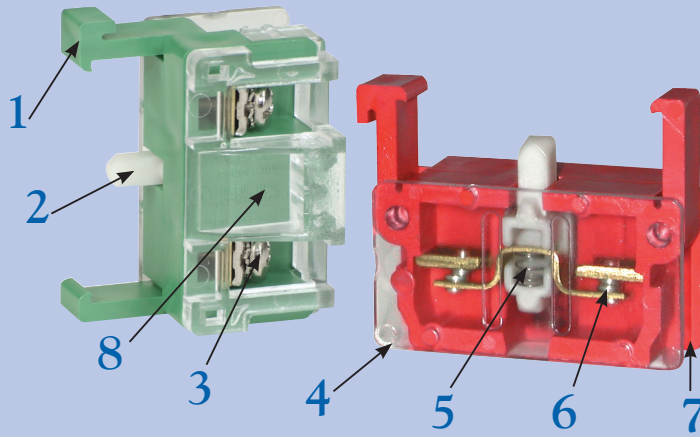

1. Vibration resistant snap-on assembly simplifies installation.
2. Selflubricating thermoplastic stroker prevents sticking and corrosive build-up that is often associated with other competitor products.
3. 35 degree angle plated steel terminal screws with captive pressure plates facilitate wiring and protect against corrosion.
4. Clear V-0 plastic covers resist combustion and aid in visual confirmation of circuit configuration.
5. Stainless steel spring for protection in corrosive environments.
6. Built-in self-wiping cleaning action and high point contact pressure for low-level switching. Silver contact rivets provide long life in normal control circuits.
7. Color-coded body for quick circuit identification (green = NO, red = NC, white = EM, black = DB).
8. Optional IP20 terminal guards protect against accidental contact with live parts. Can be ordered separately as an accessory or factory assembled providing the convenience of a single catalog number.

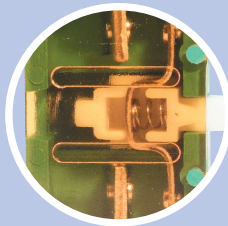

NOTE: Gold plated contacts are available on standard blocks for dry circuit applications. The cover will be gold (amber) in place of clear.

AVAILABLE CONTACT BLOCKS FOR ORDINARY LOCATIONS

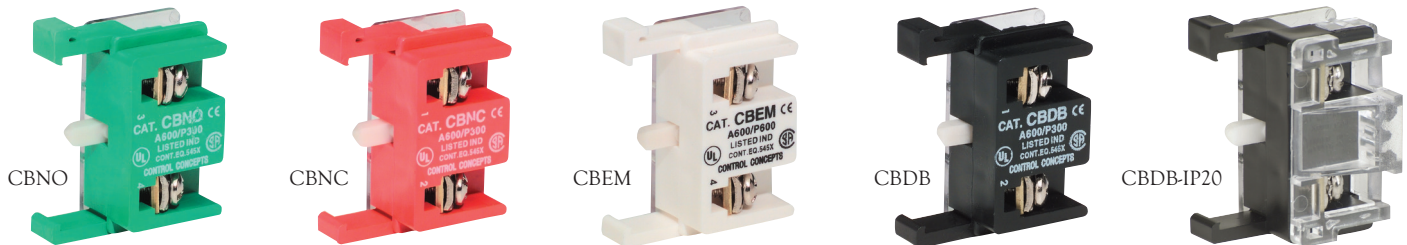

IT'S EASY TO BUILD YOUR OWN PUSH BUTTON

Simply pick the code number from each of the sections below and combine them to build your part number.

Momentary Push Buttons (Non-Illuminated)

PBO - - / -
I II III IV V VI VII

Example: To build one of our most popular Push Buttons, the part number would be **PBO + II + III + IV + V + VI + VII** or **PBO-FCGN-NO-IP20**

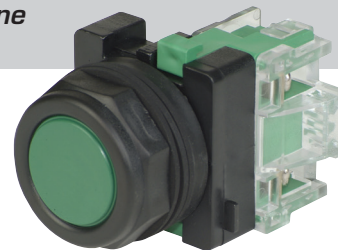

I. OPERATOR TYPE

CODE	DESCRIPTION	LIST
PBO	Push Button Operator	\$18.00

II. CLAMP RING

CODE	DESCRIPTION	LIST
FOR USE WITH ALL CAP TYPES (EXCLUDES RUBBER BOOTS)		
(Blank)	Black Polyester (Type 4X)	—
A	Aluminum (Type 4)*	\$ 4.30
FOR USE WITH RUBBER BOOTS		
(Blank)	Clamp Ring Included**	—

*NOTE: Aluminum clamp rings are NOT an option for SMC or SJC cap types.

**NOTE: Rubber boots come standard with a built in clamp ring and thrust washer. When installing the operator we recommend that the thrust washer be placed behind the panel to prevent rotation.

III. CAP TYPE

CODE	DESCRIPTION	LIST
(Blank)	Operator less	—
FC	Flush	\$ 5.20
GFC	Guarded Flush	\$12.00
XC	Extended	\$ 5.20
GXC	Guarded Extended	\$12.00
MC	Mushroom	\$17.00
JMC	Jumbo Mushroom	\$22.00
SMC	Shrouded Mushroom*	\$26.00
SJC	Shrouded Jumbo Mushroom*	\$30.00
RB	Neoprene Rubber Boot‡	\$32.00
HRB	Fluorosilicone Rubber Boot‡	\$39.00

*NOTE: Aluminum clamp rings are NOT an option for SMC or SJC.

‡NOTE: Rubber boots come standard with a built in clamp ring and thrust washer. When installing the operator we recommend that the thrust washer be placed behind the panel to prevent rotation.

IV. CAP COLOR

CODE	COLOR
ALL CAP TYPES (EXCLUDES RUBBER BOOTS)	
(Blank)	Operator less Cap
BK	Black
BE	Blue
GN	Green
GY	Grey
RD	Red
WE	White
YW	Yellow
RUBBER BOOTS	
BK	Black
GN	Green
RD	Red
YW	Yellow

V. CONTACT BLOCK CONFIGURATION (LEFT SIDE)

CODE	DESCRIPTION	LIST
(Blank)	Operator without Contact Blocks	—
NO	1 Normally Open Contact Block	\$13.00
NC	1 Normally Closed Contact Block	\$13.00
EM	1 Early Make Contact Block	\$17.00
DB	1 Delayed Break Contact Block	\$17.00
NO-NO	2 Normally Open Contact Blocks	\$26.00
NC-NC	2 Normally Closed Contact Blocks	\$26.00
NO-NC	1 Normally Open and 1 Normally Closed Contact Blocks	\$26.00

VI. CONTACT BLOCK CONFIGURATION (RIGHT SIDE)

(USE CHART V FROM ABOVE)

VII. OPTIONS

CODE	DESCRIPTION	LIST/PC*
(Blank)	None	—
IP20	IP20 Guard	\$ 4.00

*NOTE: When choosing the IP20 option, in order to achieve IP20 protection a terminal guard must be assembled on each contact block configuration, increasing the List price \$4.00 for each guard.

DISCOUNT
SCHEDULE **E**

MIX AND MATCH ANY COLOR AND MOMENTARY NON-ILLUMINATED PUSH BUTTON CAP



Flush Cap

Guarded
Flush Cap

Extended Cap

Guarded
Extended Cap

Mushroom Cap
(1-1/2" (38mm) dia.)

Jumbo
Mushroom Cap
(2-1/4" (57mm) dia.)

Shrouded
Mushroom Cap
(1-1/2" (38mm) dia.)

Shrouded Jumbo
Mushroom Cap
(2-1/4" (57mm) dia.)

Rubber Boot

30MM MOMENTARY NON-ILLUMINATED PUSH BUTTONS

c3controls goes the extra step to make sure that our products outlast the competition. Our 30mm Momentary Non-Illuminated Push Buttons are durable and flexible for a variety of uses. All c3controls 30mm operators are UL Listed and are rated Type 4/4X as standard for watertight and corrosion resistance. In addition, operators are also listed for Type 1, 2, 3, 3R, 12 and 13, and meet global standards requirements.

Product features include:

- Polyester construction for superior corrosion resistance, moisture rejection and electrical insulation.
- Polyester or polished aluminum clamp rings with coarse 16 pitch threads.
- Available in both Neoprene and Fluorosilicone, our state-of-the-art rubber boots protect the operators and the circuits behind them from harsh chemicals and climates.
- #6 terminal screws with self-lifting captive wire clamps accommodate #22 through two #12 AWG wires (0.5 - 4mm²) per terminal.
- Operators conveniently mount in a round 1-13/64" (30.5mm) hole that is directly interchangeable with competitors units and eliminates the labor required for notching.



30MM INDUSTRIAL PILOT DEVICES

UNIQUE PRODUCT FEATURES

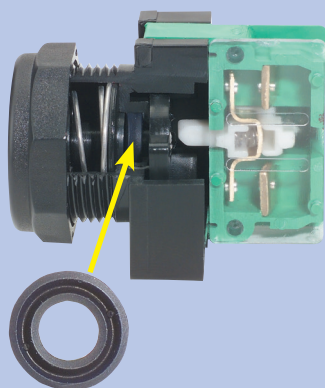

1. Our revolutionary U-Cup seal is infused with a Teflon coating to eliminate cracking when exposed to harsh conditions such as heat, dryness and sunlight. The U-Cup seal rides easily along the stroker and keeps water, oils, dust and other corrosive particles in the air away from the contact blocks. This U-cup seal also acts like a squeegee and forms a permanent watertight seal that meets Type 4/4X with or without a rubber boot. *In fact, our push button was the first to be rated Type 4X without using a rubber boot!*
2. Our push buttons modular design provides endless options for appropriate operator interface with a variety of interchangeable cap types and colors which ultimately will save you time and money by reducing your inventory.

SOME OF OUR POPULAR CONFIGURATIONS:



**SNAP-ON IP20
TERMINAL GUARDS**
protect against accidental
contact with live parts.
See page 32.

MOMENTARY NON-ILLUMINATED PUSH BUTTON OPERATORS WITH POLYESTER CLAMP RING (TYPE 4X)

	FLUSH CAP			EXTENDED CAP	
	CAP COLOR	CATALOG NUMBER	LIST	CATALOG NUMBER	LIST
1NO	Black	PBO-FCBK-NO	\$36.20	PBO-XCBK-NO	\$36.20
	Green	PBO-FCGN-NO	\$36.20	PBO-XCGN-NO	\$36.20
	Red	PBO-FCRD-NO	\$36.20	PBO-XCRD-NO	\$36.20
1NC	Black	PBO-FCBK-NC	\$36.20	PBO-XCBK-NC	\$36.20
	Green	PBO-FCGN-NC	\$36.20	PBO-XCGN-NC	\$36.20
	Red	PBO-FCRD-NC	\$36.20	PBO-XCRD-NC	\$36.20
1 NO &	Black	PBO-FCBK-NO/NC	\$49.20	PBO-XCBK-NO/NC	\$49.20
	Green	PBO-FCGN-NO/NC	\$49.20	PBO-XCGN-NO/NC	\$49.20
1 NC	Red	PBO-FCRD-NO/NC	\$49.20	PBO-XCRD-NO/NC	\$49.20

IT'S EASY TO BUILD YOUR OWN PUSH BUTTON

Simply pick the code number from each of the sections below and combine them to build your part number.

Maintained Push Buttons (Non-Illuminated)

2-Position Push-Pull

PBO - **PP** - **VI** / **VII** - **VIII**

I II III IV V VI VII VIII

Example: To build one of our most popular Push Buttons, the part number would be **PBO + II + PP + IV + V + VI + VII + VIII** or **PBO-PPMCGN-NO**



I. OPERATOR TYPE

CODE	DESCRIPTION	LIST
PBO	Push Button Operator	\$18.00

II. CLAMP RING

CODE	DESCRIPTION	LIST
(Blank)	Black Polyester (Type 4X)	—
Y	Yellow Polyester (Type 4X)	\$ 4.30
A	Aluminum (Type 4)	\$ 4.30

III. CAP FUNCTION

CODE	DESCRIPTION	LIST
PP	Push-Pull Maintained	\$57.00

IV. CAP TYPE

CODE	DESCRIPTION	LIST
MC	Mushroom	—
JMC	Jumbo Mushroom	\$ 8.60

V. CAP COLOR

CODE	COLOR
BK	Black
BE	Blue
GN	Green
GY	Grey
RD	Red
WE	White
YW	Yellow

VI. CONTACT BLOCK CONFIGURATION (LEFT SIDE)

CODE	DESCRIPTION	LIST
(Blank)	Operator without Contact Blocks	—
NO	1 Normally Open Contact Block	\$13.00
NC	1 Normally Closed Contact Block	\$13.00
EM	1 Early Make Contact Block	\$17.00
DB	1 Delayed Break Contact Block	\$17.00
NO-NO	2 Normally Open Contact Blocks	\$26.00
NC-NC	2 Normally Closed Contact Blocks	\$26.00
NO-NC	1 Normally Open and 1 Normally Closed Contact Blocks	\$26.00

VII. CONTACT BLOCK CONFIGURATION (RIGHT SIDE)

(USE CHART VI FROM ABOVE)

VIII. OPTIONS

CODE	DESCRIPTION	LIST/PC*
(Blank)	None	—
IP20	IP20 Guard	\$ 4.00

*NOTE: When choosing the IP20 option, in order to achieve IP20 protection a terminal guard must be assembled on each contact block configuration, increasing the List price \$4.00 for each guard.

The 2-Position Push-Pull is maintained in both the push and pull positions. The primary application is “push” to “stop” and “pull” to “start”.

O = OPEN X = CLOSED

MAINTAINED IN/MAINTAINED OUT					
1 CIRCUIT (1 NC)		2 CIRCUIT (1 NO/1 NC)		2 CIRCUIT (2 NC)	
OUT	IN	OUT	IN	OUT	IN
NC	X	O	NC	X	O
			NO	O	X
			NC	X	O

DISCOUNT SCHEDULE **E**

SNAP-ON IP20 TERMINAL GUARDS
protect against accidental contact with live parts.
See page 32.

MIX AND MATCH ANY COLOR AND PUSH-PULL MAINTAINED NON-ILLUMINATED CAP

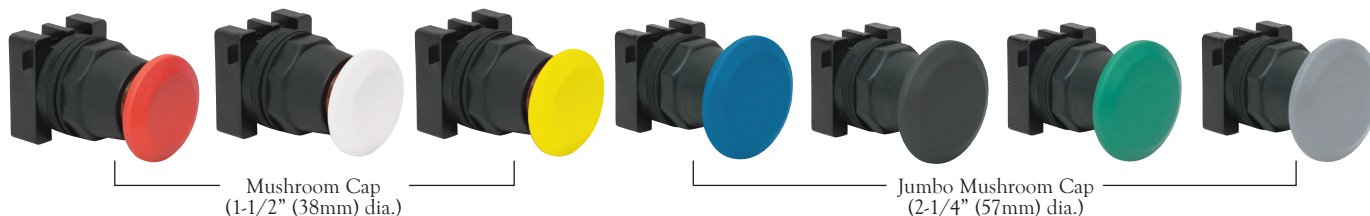

30MM MAINTAINED NON-ILLUMINATED PUSH BUTTONS

**THE MOST RUGGED EMERGENCY STOP AVAILABLE
IN THE INDUSTRY!**

All c3controls 30mm operators are UL Listed and are rated Type 4/4X as standard for watertight and corrosion resistance. In addition, operators are also listed for Type 1, 2, 3, 3R, 12 and 13, and meet global standards requirements.

Product features include:

- Polyester construction for superior corrosion resistance, moisture rejection and electrical insulation.
- Polyester or polished aluminum clamp rings with coarse 16 pitch threads that easily thread on and won't cross thread or strip.
- All cap types are secured by the clamp ring once installed for tamper protection, unlike snap-on/snap-out caps used by others.
- #6 terminal screws with self-lifting captive wire clamps accommodate #22 through two #12 AWG wires (0.5 - 4mm²) per terminal.
- Operators conveniently mount in a round 1-13/64" (30.5mm) hole that is directly interchangeable with competitors units and eliminates the labor required for notching.

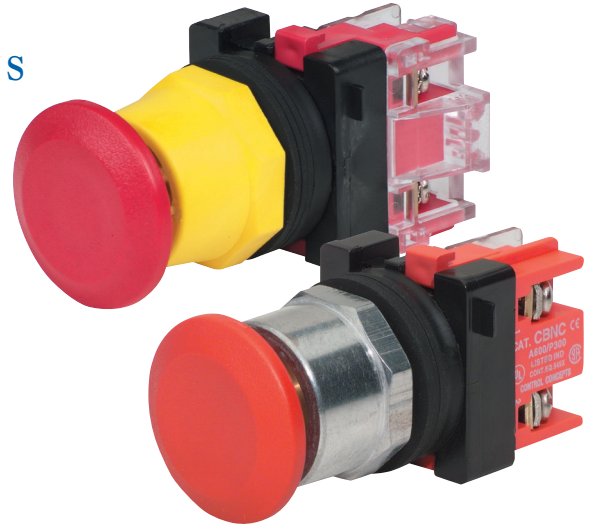

30MM INDUSTRIAL PILOT DEVICES

UNIQUE PRODUCT FEATURES

We Put The Metal On The Inside — Where It Counts!



c3controls Emergency Stops contain a solid brass detent mechanism and are the best-engineered, most reliable heavy-duty emergency stop buttons in the world. This rugged design, which comes standard with a polyester clamp ring or optional aluminum clamp ring, ensures reliable operation in emergency applications, providing safe interruption of circuits, and much longer life when compared to any competitor's product. A stainless steel version is also available for corrosive environments (see Section 14 Pages 8 & 9).

SOME OF OUR POPULAR CONFIGURATIONS:

2-POSITION PUSH-PULL MAINTAINED NON-ILLUMINATED OPERATORS WITH POLYESTER CLAMP RING (TYPE 4X)

	1 CIRCUIT (1 NC)		2 CIRCUIT (1 NO/1 NC)		2 CIRCUIT (2 NC)	
COLOR	CATALOG NUMBER	LIST	CATALOG NUMBER	LIST	CATALOG NUMBER	LIST
Black	PBO-PPMCBK-NC	\$ 88.00	PBO-PPMCBK-NO/NC	\$101.00	PBO-PPMCBK-NC/NC	\$101.00
Green	PBO-PPMCGN-NC	\$ 88.00	PBO-PPMCGN-NO/NC	\$101.00	PBO-PPMCGN-NC/NC	\$101.00
Red	PBO-PPMCRD-NC	\$ 88.00	PBO-PPMCRD-NO/NC	\$101.00	PBO-PPMCRD-NC/NC	\$101.00
Yellow	PBO-PPMCYW-NC	\$ 88.00	PBO-PPMCYW-NO/NC	\$101.00	PBO-PPMCYW-NC/NC	\$101.00

IT'S EASY TO BUILD YOUR OWN PUSH BUTTON

Simply pick the code number from each of the sections below and combine them to build your part number.

Maintained Push Buttons (Non-Illuminated)

2-Position Push-Twist Release

PTR - **TMC** - / -

I II III IV V VI VII

Example: To build one of our most popular Push Buttons, the part number would be **PTR + II + TMC + IV + V + VI + VII** or **PTR-TMCGN-NO**



I. OPERATOR TYPE		
CODE	DESCRIPTION	LIST
PTR	Push-Twist Release	\$65.00

III. CAP TYPE		
CODE	DESCRIPTION	LIST
TMC	Twist Mushroom	\$17.00

V. CONTACT BLOCK CONFIGURATION (LEFT SIDE)		
CODE	DESCRIPTION	LIST
(Blank)	Operator without Contact Blocks	—
NO	1 Normally Open Contact Block	\$13.00
NC	1 Normally Closed Contact Block	\$13.00
EM	1 Early Make Contact Block	\$17.00
DB	1 Delayed Break Contact Block	\$17.00
NO-NO	2 Normally Open Contact Blocks	\$26.00
NC-NC	2 Normally Closed Contact Blocks	\$26.00
NO-NC	1 Normally Open and 1 Normally Closed Contact Blocks	\$26.00

II. CLAMP RING		
CODE	DESCRIPTION	LIST
(Blank)	Black Polyester (Type 4X)	—
Y	Yellow Polyester (Type 4X)	\$ 4.30
A	Aluminum (Type 4)	\$ 4.30

IV. CAP COLOR	
CODE	COLOR
BK	Black
BE	Blue
GN	Green
GY	Grey
RD	Red
WE	White
YW	Yellow

VI. CONTACT BLOCK CONFIGURATION (RIGHT SIDE)		
CODE	DESCRIPTION	LIST
(USE CHART V FROM ABOVE)		

The linear push off twist to release style operator requires a “twist” for the “out” or “on” position and a linear “push” for the “in” or “off” position. The twist mushroom cap is marked with arrows identifying the direction for the twist release.

O = OPEN X = CLOSED

DISCOUNT SCHEDULE **E**

MAINTAINED IN/MAINTAINED OUT					
1 CIRCUIT (1 NC)		2 CIRCUIT (1 NO/1 NC)		2 CIRCUIT (2 NC)	
OUT	IN	OUT	IN	OUT	IN
NC	X 0	NC	X 0	NC	X 0
		NO	0 X	NC	X 0

VII. OPTIONS		
CODE	DESCRIPTION	LIST/PC*
(Blank)	None	—
IP20	IP20 Guard	\$ 4.00

*NOTE: When choosing the IP20 option, in order to achieve IP20 protection a terminal guard must be assembled on each contact block configuration, increasing the List price \$4.00 for each guard.

SOME OF OUR POPULAR CONFIGURATIONS:

2-POSITION PUSH-TWIST RELEASE MAINTAINED NON-ILLUMINATED OPERATORS WITH POLYESTER CLAMP RING (TYPE 4X)						
	1 CIRCUIT (1 NC)		2 CIRCUIT (1 NO/1 NC)		2 CIRCUIT (2 NC)	
COLOR	CATALOG NUMBER	LIST	CATALOG NUMBER	LIST	CATALOG NUMBER	LIST
Black	PTR-TMCBK-NC	\$ 95.00	PTR-TMCBK-NO/NC	\$108.00	PTR-TMCBK-NC/NC	\$108.00
Green	PTR-TMCGN-NC	\$ 95.00	PTR-TMCGN-NO/NC	\$108.00	PTR-TMCGN-NC/NC	\$108.00
Red	PTR-TMCRD-NC	\$ 95.00	PTR-TMCRD-NO/NC	\$108.00	PTR-TMCRD-NC/NC	\$108.00
Yellow	PTR-TMICYW-NC	\$ 95.00	PTR-TMICYW-NO/NC	\$108.00	PTR-TMICYW-NC/NC	\$108.00

AVAILABLE CAP COLORS FOR 2-POSITION AND 3-POSITION MAINTAINED NON-ILLUMINATED PUSH BUTTONS

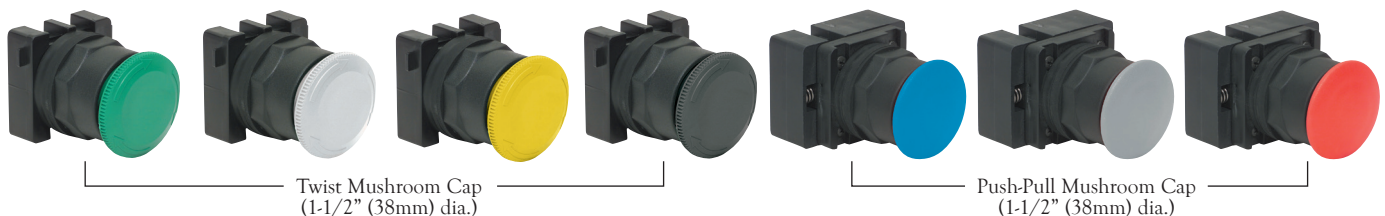

IT'S EASY TO BUILD YOUR OWN PUSH BUTTON

Simply pick the code number from each of the sections below and combine them to build your part number.

Maintained Push Buttons (Non-Illuminated)

3-Position Push-Pull

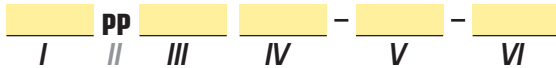

Example: To build one of our most popular Push Buttons, the part number would be **I + PP + III + IV + V + VI** or **PPMIRD-NC-DB**



I. CLAMP RING		
CODE	DESCRIPTION	LIST
(Blank)	Black Polyester (Type 4X)	—
Y	Yellow Polyester (Type 4X)	\$ 4.30
A	Aluminum (Type 4)	\$ 4.30

II. OPERATOR TYPE		
CODE	DESCRIPTION	LIST
PP	Push-Pull Maintained	\$58.00

III. OPERATOR FUNCTION	
CODE	DESCRIPTION
MI	Momentary Out, Maintained Center, Maintained In
AC	Momentary Out, Maintained Center, Momentary In

IV. MUSHROOM CAP/COLOR		
CODE	COLOR	LIST
BK	Black	\$17.00
BE	Blue	\$17.00
GN	Green	\$17.00
GY	Grey	\$17.00
RD	Red	\$17.00
WE	White	\$17.00
YW	Yellow	\$17.00

V. CONTACT BLOCK CONFIGURATION*		
CODE	DESCRIPTION	LIST
(Blank)	Operator without Contact Blocks	—
NC-DB	1 Normally Closed and 1 Delayed Break Contact Blocks	\$30.00
NO-NC	1 Normally Open and 1 Normally Closed Contact Blocks	\$26.00

*NOTE: Contact blocks mount on one side only.

VI. OPTIONS		
CODE	DESCRIPTION	LIST/PC*
(Blank)	None	—
IP20	IP20 Guard	\$ 4.00

*NOTE: When choosing the IP20 option, in order to achieve IP20 protection a terminal guard must be assembled on each contact block configuration, increasing the List price \$4.00 for each guard.

The 3-Position Push-Pull device is available in two basic styles. One version features the “out” position as momentary, the “center” position as maintained, and the “in” position as maintained. The other version features the “center” position as maintained while the “out” and “in” positions are momentary.

O = OPEN X = CLOSED

MOMENTARY OUT, MAINTAINED CENTER, MAINTAINED IN			MOMENTARY OUT, MAINTAINED CENTER, MOMENTARY IN		
OUT	CENTER	IN	OUT	CENTER	IN
NC	X	O	NC	X	O
DB	X	X	DB	X	O
NO	O	O	NO	O	X
NC	X	O	NC	X	O



SNAP-ON IP20 TERMINAL GUARDS
protect against accidental contact with live parts.
See page 32.

SOME OF OUR POPULAR CONFIGURATIONS:

3-POSITION PUSH-PULL MAINTAINED NON-ILLUMINATED OPERATORS WITH POLYESTER CLAMP RING (TYPE 4X)				
COLOR	MOMENTARY OUT, MAINTAINED CENTER, MAINTAINED IN		MOMENTARY OUT, MAINTAINED CENTER MOMENTARY IN	
	CATALOG NUMBER	LIST	CATALOG NUMBER	LIST
Black	PPMIBK-NC-DB	\$105.00	PPACBK-NC-DB	\$105.00
Green	PPMIGN-NC-DB	\$105.00	PPACGN-NC-DB	\$105.00
Red	PPMIRD-NC-DB	\$105.00	PPACRD-NC-DB	\$105.00
Yellow	PPMIYW-NC-DB	\$105.00	PPACYW-NC-DB	\$105.00

SEE BOTTOM OF PAGE 10 FOR CAP COLOR OPTIONS.

IT'S EASY TO BUILD YOUR OWN PUSH BUTTON

Simply pick the code number from each of the sections below and combine them to build your part number.

Momentary Push Buttons (Illuminated)*



Example: To build one of our most popular Push Buttons, the part number would be **I + II + III + IV + V + VI + VII + VIII** or **FVLUI20-IPBCGN-NO-IP20**

*NOTE: Our momentary illuminated push buttons must be ordered as an assembled part. Contact blocks may be ordered separately.



I. ILLUMINATED PUSH BUTTON OPERATOR

CODE	DESCRIPTION	LIST
FVLU	Full Voltage	\$46.00
RLU	Resistor	\$57.00
RTL	Dual Input Remote Test	\$62.00

II. VOLTAGE BASED ON OPERATOR TYPE

CODE	DESCRIPTION
FULL VOLTAGE	
6	6V AC/DC
12	12V AC/DC
24	24V AC/DC
120	120V AC/DC
RESISTOR	
120	120V AC/DC
240	240V AC/DC
480	480V AC/DC (LED & Neon only)
DUAL INPUT REMOTE TEST	
6	6V AC/DC
12	12V AC/DC
24	24V AC/DC
120	120V AC/DC

III. LAMP TYPE/COLOR

CODE	COLOR	LIST
LED		
LA	Amber	\$18.00
LB	Blue	\$18.00
LG	Green	\$18.00
LR	Red	\$18.00
LW	White	\$18.00
INCANDESCENT		
(Blank)	Clear†	—
†NOTE: Incandescent bulbs are not an option for RLU480.		
F	Clear Flashing Bulb*	\$ 7.10
*NOTE: Incandescent flashing bulbs available for any 6V full voltage application.		
NEON†		
NG	Green	—
NR	Red	—
†NOTE: Only Available in FVLUI20, RLU240 and RLU480.		
NL	No Lamp	— \$ 1.80

VI. LENS COLOR

CODE	COLOR
AR	Amber
BE	Blue
CR	Clear
GN	Green
RD	Red
WE	White
YW	Yellow

VII. CONTACT BLOCK CONFIGURATION*

CODE	DESCRIPTION	LIST
(Blank)	Operator without Contact Blocks	—
NO	1 Normally Open Contact Block	\$13.00
NC	1 Normally Closed Contact Block	\$13.00
EM	1 Early Make Contact Block	\$17.00
DB	1 Delayed Break Contact Block	\$17.00
NO-NO	2 Normally Open Contact Blocks	\$26.00
NC-NC	2 Normally Closed Contact Blocks	\$26.00
NO-NC	1 Normally Open and 1 Normally Closed Contact Blocks	\$26.00

*NOTE: Contact blocks mount on one side only.

IV. CLAMP RING

CODE	DESCRIPTION	LIST
(Blank)	Black Polyester (Type 4X)	—
A	Aluminum (Type 4)	\$ 4.30

V. LENS TYPE

CODE	DESCRIPTION	LIST
IPBC	Illuminated Push Button Lens	\$24.00
IPBCM	Illuminated Push Button Mushroom Lens	\$36.00
GIPBC	Guarded Illuminated Push Button Lens*	\$36.00
SIPBCM	Shrouded Illuminated Push Button Mushroom Lens*	\$48.00

*NOTE: Aluminum clamp rings are not an option for GIPBC or SIPBCM.

VIII. OPTIONS

CODE	DESCRIPTION	LIST/PC*
(Blank)	None	—
IP20	IP20 Guard	\$ 4.00

*NOTE: When choosing the IP20 option, in order to achieve IP20 protection a terminal guard must be assembled on the light module and each contact block configuration, increasing the List price \$4.00 for each guard.

IP20 terminal guards are not available for RTL.



SEE PAGE 33 FOR LAMP REPLACEMENT CHART AND PAGE 34 FOR LAMP TECHNICAL DATA.

MIX AND MATCH ANY COLOR AND MOMENTARY ILLUMINATED PUSH BUTTON LENS



30MM MOMENTARY ILLUMINATED PUSH BUTTONS

c3controls goes the extra step to make sure that our products outlast the competition. Our 30mm Momentary Illuminated Push Buttons are durable and flexible for a variety of uses. All c3controls 30mm operators are UL Listed and are rated Type 4/4X as standard for watertight and corrosion resistance. In addition, operators are also listed for Type 1, 2, 3, 3R, 12 and 13, and meet global standards requirements.

Product features include:

- Polyester construction for superior corrosion resistance, moisture rejection and electrical insulation.
- Polyester or polished aluminum clamp rings.
- Full voltage lights incorporate a unique insulated socket design to minimize accidental contact during lamp change.
- All lights use miniature bayonet base lamps to provide reliable lamp secureness.
- Available with Incandescent, Neon, or our LED lamps with leakage protection.
- #6 terminal screws with self-lifting captive wire clamps accommodate #22 through two #12 AWG wires (0.5 - 4mm²) per terminal.
- Operators conveniently mount in a round 1-13/64" (30.5mm) hole that is directly interchangeable with competitors units and eliminates the labor required for notching.



30MM INDUSTRIAL PILOT DEVICES

UNIQUE PRODUCT FEATURES



1. Our revolutionary U-Cup seal is infused with a Teflon coating to eliminate cracking when exposed to harsh conditions such as heat, dryness and sunlight. The U-Cup seal rides easily along the stroker and keeps water, oils, dust and other corrosive particles in the air away from the contact blocks. This U-cup seal also acts like a squeegee and forms a permanent watertight seal that meets Type 4/4X standards.
2. All frictional parts are molded with an internal self lubricant to provide outstanding wear without troublesome greases used by others.
3. Our rugged Lexan™ caps can resist high impact for reliable performance in most environments even in high ambient temperatures.

SOME OF OUR POPULAR CONFIGURATIONS:

MOMENTARY ILLUMINATED PUSH BUTTON OPERATORS WITH POLYESTER CLAMP RING (TYPE 4X)

	PUSH BUTTON LENS		MUSHROOM LENS	
	LENS COLOR	CATALOG NUMBER	LIST	LIST
Full Voltage	Amber	FVLU120-IPBCAR-NO-NC	\$ 96.00	FVLU120-IPBCMAR-NO-NC \$108.00
	Green	FVLU120-IPBCGN-NO	\$ 83.00	FVLU120-IPBCMGN-NO \$ 95.00
	Red	FVLU120-IPBCRD-NC	\$ 83.00	FVLU120-IPBCMRD-NC \$ 95.00
Resistor	Amber	RLU120-IPBCAR-NO-NC	\$107.00	RLU120-IPBCMAR-NO-NC \$119.00
	Green	RLU120-IPBCGN-NO	\$ 94.00	RLU120-IPBCMGN-NO \$106.00
	Red	RLU120-IPBCRD-NC	\$ 94.00	RLU120-IPBCMRD-NC \$106.00
LED	Amber	RLU240LA-IPBCAR-NO-NC	\$125.00	RLU240LA-IPBCMAR-NO-NC \$137.00
	Green	FVLU120LG-IPBCGN-NO	\$101.00	FVLU120LG-IPBCMGN-NO \$113.00
	Red	FVLU120LR-IPBCRD-NC	\$101.00	FVLU120LR-IPBCMRD-NC \$113.00

DUAL INPUT REMOTE TEST

Our unique Dual Input Remote light unit can be used as an illuminated push button while also permitting the testing of a number of lights from a single push button. A diode circuit isolates the test supply from the normal supply.

The schematic shown represents a typical dual input application.

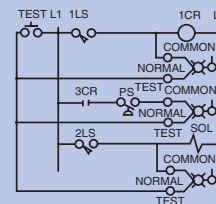

IT'S EASY TO BUILD YOUR OWN PUSH BUTTON

Simply pick the code number from each of the sections below and combine them to build your part number.

Maintained Push Buttons (Illuminated)
2-Position Push-Pull



Example: To build one of our most popular Push Buttons, the part number would be **I + PPM + III + IV + V + IMC + VII + VIII + IX** or **FVPPM120-IMCGN-NO**



I. ILLUMINATED PUSH BUTTON OPERATOR

CODE	DESCRIPTION
FV	Full Voltage
RL	Resistor

II. OPERATOR TYPE

CODE	DESCRIPTION	LIST
PPM	Push-Pull Maintained	\$79.00

III. VOLTAGE BASED ON OPERATOR TYPE

CODE	DESCRIPTION
FULL VOLTAGE	
6	6V AC/DC
12	12V AC/DC
24	24V AC/DC
120	120V AC/DC
RESISTOR	
120	120V AC/DC
240	240V AC/DC
480	480V AC/DC (LED & Neon only)

IV. LAMP TYPE/COLOR

CODE	COLOR	LIST
LED		
LA	Amber	\$18.00
LB	Blue	\$18.00
LG	Green	\$18.00
LR	Red	\$18.00
LW	White	\$18.00
INCANDESCENT		
(Blank)	Clear†	—
†NOTE: Incandescent bulbs are not an option for RLPPM480.		
F	Clear Flashing Bulb*	\$ 7.10
*NOTE: Incandescent flashing bulbs available for any 6V full voltage application.		
NEON†		
NG	Green	—
NR	Red	—
†NOTE: Only Available in FVPPM120, RLPPM240 and RLPPM480.		
NL	No Lamp	— \$ 1.80

V. CLAMP RING

CODE	DESCRIPTION	LIST
(Blank)	Black Polyester (Type 4X)	—
A	Aluminum (Type 4)	\$ 4.30

VI. LENS TYPE

CODE	DESCRIPTION	LIST
IMC	Illuminated Mushroom Lens	\$36.00

VII. LENS COLOR

CODE	COLOR
AR	Amber
BE	Blue
CR	Clear
GN	Green
RD	Red
WE	White

VIII. CONTACT BLOCK CONFIGURATION*

CODE	DESCRIPTION	LIST
(Blank)	Operator without Contact Blocks	—
NO	1 Normally Open Contact Block	\$13.00
NC	1 Normally Closed Contact Block	\$13.00
EM	1 Early Make Contact Block	\$17.00
DB	1 Delayed Break Contact Block	\$17.00
NO-NO	2 Normally Open Contact Blocks	\$26.00
NC-NC	2 Normally Closed Contact Blocks	\$26.00
NO-NC	1 Normally Open and 1 Normally Closed Contact Blocks	\$26.00

*NOTE: Contact blocks mount on one side only.

IX. OPTIONS

CODE	DESCRIPTION	LIST/PC*
(Blank)	None	—
IP20	IP20 Guard	\$ 4.00

*NOTE: When choosing the IP20 option, in order to achieve IP20 protection a terminal guard must be assembled on each contact block configuration, increasing the List price \$4.00 for each guard.

The 2-Position Push-Pull is maintained in both the push and pull positions. The primary application is “push” to “stop” and “pull” to “start”.

SEE PAGE 33 FOR LAMP REPLACEMENT CHART AND PAGE 34 FOR LAMP TECHNICAL DATA.

SEE PAGE 15 FOR CIRCUIT DIAGRAM CHART.



AVAILABLE LENS COLORS FOR 2-POSITION AND 3-POSITION MAINTAINED ILLUMINATED PUSH BUTTONS

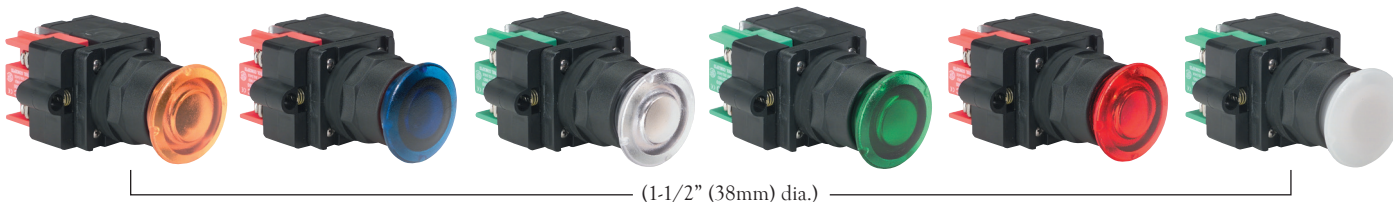

30MM MAINTAINED ILLUMINATED PUSH BUTTONS

c3controls goes the extra step to make sure that our products outlast the competition. Our 30mm Maintained Illuminated Push Buttons are durable and flexible for a variety of uses. All c3controls 30mm operators are UL Listed and are rated Type 4/4X as standard for watertight and corrosion resistance. In addition, operators are also listed for Type 1, 2, 3, 3R, 12 and 13, and meet global standards requirements.

Product features include:

- Polyester construction for superior corrosion resistance, moisture rejection and electrical insulation.
- Polyester or polished aluminum clamp rings with coarse 16 pitch threads that easily thread on and won't cross thread or strip.
- Full voltage lights incorporate a unique insulated socket design to minimize accidental contact during lamp change.
- All lights use miniature bayonet base lamps to provide reliable lamp secureness.
- Available with Incandescent, Neon or our LED lamps with leakage protection.
- #6 terminal screws with self-lifting captive wire clamps accommodate #22 through two #12 AWG wires (0.5 - 4mm²) per terminal.
- Operators conveniently mount in a round 1-13/64" (30.5mm) hole that is directly interchangeable with competitors units and eliminates the labor required for notching.



30MM INDUSTRIAL PILOT DEVICES

UNIQUE PRODUCT FEATURES

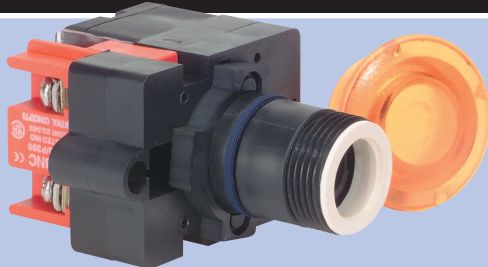

1. Our seal is infused with a coating to eliminate cracking when exposed to harsh conditions such as heat, dryness and sunlight. This seal also acts as a light reflector because it is white which increases light output and improves visibility from all angles.
2. All frictional parts are molded with an internal self lubricant to provide outstanding wear without troublesome greases used by others.
3. Our rugged Lexan™ caps can resist high impact for reliable performance in most environments even in high ambient temperatures.

2-POSITION PUSH-PULL MAINTAINED ILLUMINATED OPERATORS CIRCUIT DIAGRAM CHART

0 = OPEN X = CLOSED

MAINTAINED IN/MAINTAINED OUT					
1 CIRCUIT (1 NC)		2 CIRCUIT (1 NO/1 NC)		2 CIRCUIT (2 NC)	
OUT	IN	OUT	IN	OUT	IN
NC	X 0	NC	X 0	NC	X 0
		NO	0 X	NC	X 0

3-POSITION PUSH-PULL MAINTAINED ILLUMINATED OPERATORS CIRCUIT DIAGRAM CHART

0 = OPEN X = CLOSED

MOMENTARY OUT, MAINTAINED CENTER, MAINTAINED IN			MOMENTARY OUT, MAINTAINED CENTER, MOMENTARY IN		
OUT	CENTER	IN	OUT	CENTER	IN
NC	X 0	0 0	NC	X 0	0 0
DB	X X	0 0	DB	X X	0 0
NO	0 0	X X	NO	0 0	X X
NC	X 0	0 0	NC	X 0	0 0

SOME OF OUR POPULAR CONFIGURATIONS:

2-POSITION PUSH-PULL MAINTAINED ILLUMINATED OPERATORS WITH POLYESTER CLAMP RING (TYPE 4X)						
	1 CIRCUIT (1 NC)		2 CIRCUIT (1 NO/1 NC)		2 CIRCUIT (2 NC)	
TYPE	CATALOG NUMBER	LIST	CATALOG NUMBER	LIST	CATALOG NUMBER	LIST
Full Voltage	FVPPM120-IMCRD-NC	\$128.00	FVPPM120-IMCRD-NO-NC	\$141.00	FVPPM120-IMCRD-NC-NC	\$141.00
Resistor	RLPPM120-IMCRD-NC	\$128.00	RLPPM120-IMCRD-NO-NC	\$141.00	RLPPM120-IMCRD-NC-NC	\$141.00

IT'S EASY TO BUILD YOUR OWN PUSH BUTTON

Simply pick the code number from each of the sections below and combine them to build your part number.

Maintained 3-Position Push-Pull Push Buttons (Illuminated)

I II III IV - V IMC VI VII - VIII - IX

Example: To build one of our most popular Push Buttons, the part number would be **I + II + III + IV + V + IMC + VII + VIII + IX** or **FVMI120-IMCRD-NC-DB**

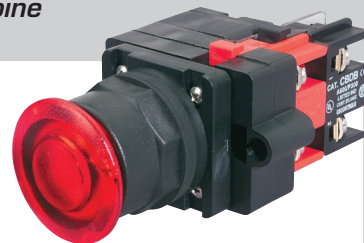

I. ILLUMINATED PUSH BUTTON OPERATOR

CODE	DESCRIPTION
FV	Full Voltage
RL	Resistor

II. OPERATOR FUNCTION

CODE	DESCRIPTION	LIST
MI	Momentary Out, Maintained Center, Maintained In	\$ 79.00
AC	Momentary Out, Maintained Center, Momentary In	\$ 79.00

III. VOLTAGE BASED ON OPERATOR TYPE

CODE	DESCRIPTION
FULL VOLTAGE	
6	6V AC/DC
12	12V AC/DC
24	24V AC/DC
120	120V AC/DC
RESISTOR	
120	120V AC/DC
240	240V AC/DC
480	480V AC/DC (LED & Neon only)

IV. LAMP TYPE/COLOR

CODE	COLOR	LIST
LED		
LA	Amber	\$ 18.00
LB	Blue	\$ 18.00
LG	Green	\$ 18.00
LR	Red	\$ 18.00
LW	White	\$ 18.00
INCANDESCENT		
(Blank)	Clear [†]	—
[†] NOTE: Incandescent bulbs are not an option for RL480.		
F	Clear Flashing Bulb*	\$ 7.10
[*] NOTE: Incandescent flashing bulbs available for any 6V full voltage application.		
NEON[†]		
NG	Green	—
NR	Red	—
[†] NOTE: Only Available in FV120, RL240 and RL480.		
NL	No Lamp	-\$ 1.80

V. CLAMP RING

CODE	DESCRIPTION	LIST
(Blank)	Black Polyester (Type 4X)	—
A	Aluminum (Type 4)	\$ 4.30

VI. LENS TYPE

CODE	DESCRIPTION	LIST
IMC	Illuminated Mushroom Lens	\$ 36.00

VII. LENS COLOR

CODE	COLOR
AR	Amber
BE	Blue
CR	Clear
GN	Green
RD	Red
WE	White

VIII. CONTACT BLOCK CONFIGURATION*

CODE	DESCRIPTION	LIST
(Blank)	Operator without Contact Blocks	—
NC-DB	1 Normally Closed and 1 Delayed Break Contact Blocks	\$ 30.00
NO-NC	1 Normally Open and 1 Normally Closed Contact Blocks	\$ 26.00

^{*}NOTE: Contact blocks mount on one side only.

IX. OPTIONS

CODE	DESCRIPTION	LIST/PC*
(Blank)	None	—
IP20	IP20 Guard	\$ 4.00

^{*}NOTE: When choosing the IP20 option, in order to achieve IP20 protection a terminal guard must be assembled on each contact block configuration, increasing the List price \$4.00 for each guard.

SEE PAGE 33 FOR LAMP REPLACEMENT CHART AND PAGE 34 FOR LAMP TECHNICAL DATA.

SEE PAGE 15 FOR CIRCUIT DIAGRAM CHART.

The 3-Position Push-Pull device is available in two basic styles. One version features the "out" position as momentary, the "center" as maintained, and the "in" position as maintained. The other version features the "center" position as maintained while the "out" and "in" positions are momentary.



SOME OF OUR POPULAR CONFIGURATIONS:

SEE BOTTOM OF PAGE 14 FOR LENS COLOR OPTIONS.

3-POSITION PUSH-PULL MAINTAINED OPERATORS WITH POLYESTER CLAMP RING (TYPE 4X)				
	MOMENTARY OUT, MAINTAINED CENTER, MAINTAINED IN		MOMENTARY OUT, MAINTAINED CENTER, MOMENTARY IN	
TYPE	CATALOG NUMBER	LIST	CATALOG NUMBER	LIST
Full Voltage	FVMI120-IMCRD-NC-DB	\$145.00	FVAC120-IMCRD-NC-DB	\$145.00
Resistor	RLMI120-IMCRD-NC-DB	\$145.00	RLAC120-IMCRD-NC-DB	\$145.00

RESET PUSH BUTTON

Our unique Reset Push Button mounts in a standard 1-13/64" (30.5mm) hole and accepts either 20 hex head bolts or 20 thread rod to provide adjustable extension and save on all rod cutting and fitting labor.



Universal styles include two bolts to cover 1" to 3" (25.4mm to 76.2mm) space from cover to overload reset rod. It is rated Type 4/4X as standard.

CODE	DESCRIPTION	LIST
RPB	Reset Push Button	\$19.00
RPB-B	RPB with Bolts (1/4-20 x 1-3/4" & 3")	\$22.00
RPB-W	RPB with Washers	\$22.00
RPB-BW	RPB with Bolt & Washer Set	\$24.00
RPB BOLTS	2 Bolts (1/4-20 x 1-3/4" & 3")	\$ 2.00
RPB WASHERS	Washer Set	\$ 2.00

Special bolt lengths available — consult factory (not available for guaranteed same day shipping).

WOBBLE STICK

Designed primarily for use with pendant stations, the wobble stick may be mounted in oil tight or watertight stations. The unit has spring return action to center and may be operated from any angle. It is rated Type 4/4X as standard. NOTE: Our Wobble Stick is a linear device similar to a push button. It is not a joystick or directional.



CODE	DESCRIPTION	LIST
WITH BLACK POLYESTER (TYPE 4X) CLAMP RING		
WS-NO/NC	with 1 NO and 1 NC	\$ 78.00
WS-NO-NO/NC-NC	with 2 NO and 2 NC	\$108.00
WITH ALUMINUM (TYPE 4) CLAMP RING		
AWS-NO/NC	with 1 NO and 1 NC	\$ 83.00
AWS-NO-NO/NC-NC	with 2 NO and 2 NC	\$113.00

CABLE PULL OPERATORS

Our unique low-energy cable pull operators are available in four styles and are UL Listed for Type 1, 2, 3, 3R, 4/4X, 12 and 13 requirements. Our cable pull operators are reverse spring biased to hold contact blocks in the operated position until a force (varies by operator) is applied to the included eyebolt. Contact operation is opposite of normal (i.e., CBNO is held closed and opens only when the eyebolt is pulled). Units are available with or without contact blocks and can be supplied in Type 4X surface mounting enclosures as a custom order (not available for guaranteed same day shipping). See Section 21 for a complete selection of our control stations.

MOMENTARY CABLE PULL OPERATOR

Constructed to withstand corrosive environments. It holds contact blocks in the operated position until a 4 - 6 pound force is applied to the included eyebolt.*



CODE	DESCRIPTION	LIST
WITH BLACK POLYESTER (TYPE 4X) CLAMP RING		
CPO	Operator Only	\$108.00
CPO-NO	with CBNO held closed	\$123.00
CPO-NC	with CBNC held open	\$123.00
WITH ALUMINUM (TYPE 4) CLAMP RING		
ACPO	Operator Only	\$113.00
ACPO-NO	with CBNO held closed	\$128.00
ACPO-NC	with CBNC held open	\$128.00

BOOTED MOMENTARY CABLE PULL OPERATOR

Provides protection in the most severe environments, such as when sleet, freeze and thaw conditions are prevalent. It holds contact blocks in the operated position until a 4 - 6 pound force is applied to the included eyebolt.*



CODE	DESCRIPTION	LIST
CPORB4	Operator only with Type 4X Boot	\$147.00

NOTE: Not available with aluminum clamp ring.

HEAVY-DUTY MOMENTARY CABLE PULL OPERATOR

Constructed of solid brass to provide the most reliable operation. It holds contact blocks in the operated position until a 13 pound force is applied to the included eyebolt.*



CODE	DESCRIPTION	LIST
WITH BLACK POLYESTER (TYPE 4X) CLAMP RING		
HDCPO	Operator Only	\$123.00
HDCPO-NO	with CBNO held closed	\$137.00
HDCPO-NC	with CBNC held open	\$137.00
WITH ALUMINUM (TYPE 4) CLAMP RING		
AHDCPO	Operator Only	\$127.00
AHDCPO-NO	with CBNO held closed	\$142.00
AHDCPO-NC	with CBNC held open	\$142.00

PUSH-PULL MAINTAINED CABLE PULL OPERATOR

Operating head is provided with a latch detent mechanism to hold the operator in the pulled or "out" position when operated. It holds contact blocks in the operated position until a 4 - 6 pound force is applied to the included eyebolt. Requires a manual reset after actuation. Also available in solid stainless steel as a custom order (not available for guaranteed same day shipping)—consult the factory.*



CODE	DESCRIPTION	LIST
WITH BLACK POLYESTER (TYPE 4X) CLAMP RING		
PPCPO	Operator Only	\$123.00
PPCPO-NO	with CBNO held closed	\$137.00
PPCPO-NC	with CBNC held open	\$137.00
WITH ALUMINUM (TYPE 4) CLAMP RING		
APPCPO	Operator Only	\$127.00
APPCPO-NO	with CBNO held closed	\$142.00
APPCPO-NC	with CBNC held open	\$142.00

*NOTE: The c3controls Cable Pull Switch is a "pull operated" switch designed to be operated by pulling on a rope or cable. It is not designed to the Machine Directives for Emergency Devices for Safeguarding Machinery. It does not offer direct drive, positive break/positive transfer contacts. It is a spring operated momentary device that operates "slow make/slow break" normally open and normally closed contact blocks. Pulling the eyebolt collapses an internal spring, which allows contact blocks mounted on the rear of the operator to open or close and actuate the intended circuit. Releasing the eyebolt allows the internal spring to return and depress the contact blocks to their original state. The device is designed to provide in excess of 1 million mechanical operations and is frequently applied in overhead door applications.



IT'S EASY TO BUILD YOUR OWN POTENTIOMETER

Simply pick the code number from each of the sections below and combine them to build your part number.

Potentiometer Operators

POTO -
I II III IV

Example: To build one of our most popular Potentiometer Operators, the part number would be **POTO + II + III + IV** or **POTO5K-TBW**

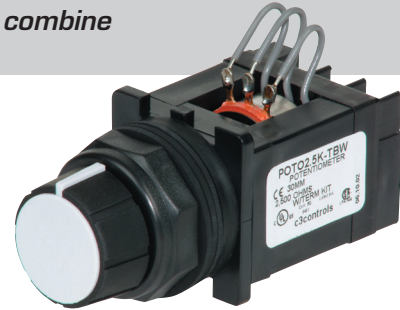

I. OPERATOR TYPE		
CODE	DESCRIPTION	LIST
POTO	Potentiometer Operator	\$58.00

II. CLAMP RING		
CODE	DESCRIPTION	LIST
(Blank)	Black Polyester (Type 4X)	—
A	Aluminum (Type 4)	\$ 4.30

III. RESISTANCE		
CODE	DESCRIPTION	LIST
(Blank)	Operator only	—
1K	1k Potentiometer	\$22.00
2.5K	2.5k Potentiometer	\$22.00
5K	5k Potentiometer	\$22.00
10K	10k Potentiometer	\$22.00

Special order values available—consult factory (not available for guaranteed same day shipping).

IV. TERMINAL BLOCK		
CODE	DESCRIPTION	LIST
(Blank)	Operator only	—
TBW	Terminal Block installed and wired	\$16.00

Terminal block kit may be ordered separately (part number TBK, List \$9.60) or installed and wired at the factory to the potentiometer operator.

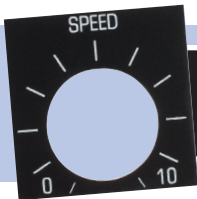

LEGEND PLATES FOR POTENTIOMETER OPERATORS are available for same day shipping. See pages 30 & 31 for complete selection.

WIRING DIAGRAM

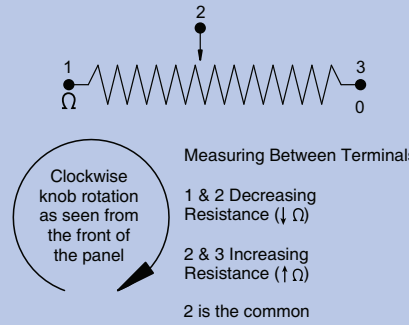

30MM POTENTIOMETER OPERATORS

Our single-turn Potentiometer Operators utilize standard 2 watt potentiometers with 1/4" (6.4mm) bushing and 7/8" (22.5mm) long slotted shafts. A 5/64" allen wrench is required for installation. All c3controls 30mm operators are UL Listed and are rated Type 4/4X as standard for watertight and corrosion resistance. In addition, operators are also listed for Type 1, 2, 3, 3R, 12 and 13, and meet global standards requirements. CSA File # LR 47446-9.

Product features include:

- Polyester construction for superior corrosion resistance, moisture rejection and electrical insulation.
- Polyester or polished aluminum clamp rings.
- Single-turn standard 2 watt potentiometer.
- #6 terminal screws with self-lifting captive wire clamps accommodate #22 through two #12 AWG wires (0.5 - 4mm²) per terminal.
- Operators conveniently mount in a round 1-13/64" (30.5mm) hole that is directly interchangeable with competitors units.



UNIQUE PRODUCT FEATURES



1. Our revolutionary U-Cup seal is infused with a Teflon coating to eliminate cracking when exposed to harsh conditions such as heat, dryness and sunlight.
2. All frictional parts are molded with an internal self-lubricant to provide outstanding wear without troublesome greases used by others that attracts dust and other particles in the area.
3. Three point terminal block and hardware.

IT'S EASY TO BUILD YOUR OWN PILOT LIGHT

Simply pick the code number from each of the sections below and combine them to build your part number.

Pilot Lights



Example: To build one of our most popular Pilot Lights, the part number would be **I + II + III + IV + PLL + VI + VII** or **FVLU120LG-PLLGN**



I. PILOT LIGHT OPERATOR

CODE	DESCRIPTION	LIST
FVLU	Full Voltage	\$46.00
RLU	Resistor	\$57.00
RTL	Dual Input Remote Test	\$62.00

II. VOLTAGE BASED ON OPERATOR TYPE

CODE	DESCRIPTION
FULL VOLTAGE	
6	6V AC/DC
12	12V AC/DC
24	24V AC/DC
120	120V AC/DC
RESISTOR	
120	120V AC/DC
240	240V AC/DC
480	480V AC/DC (LED & Neon only)
DUAL INPUT REMOTE TEST	
6	6V AC/DC
12	12V AC/DC
24	24V AC/DC
120	120V AC/DC
240	240V AC/DC

III. LAMP TYPE/COLOR

CODE	COLOR	LIST
LED		
LA	Amber	\$18.00
LB	Blue	\$18.00
LG	Green	\$18.00
LR	Red	\$18.00
LW	White	\$18.00
INCANDESCENT		
(Blank)	Clear†	—
†NOTE: Incandescent bulbs are not an option for RLU480.		
F	Clear Flashing Bulb*	\$ 7.10
*NOTE: Incandescent flashing bulbs available for any 6V full voltage application.		
NEON†		
NG	Green	—
NR	Red	—
†NOTE: Only Available in FVLU120, RLU240 and RLU480.		
NL	No Lamp	— \$ 1.80

SEE PAGE 33 FOR LAMP REPLACEMENT CHART AND PAGE 34 FOR LAMP TECHNICAL DATA.

IV. CLAMP RING

CODE	DESCRIPTION	LIST
(Blank)	Black Polyester (Type 4X)	—
A	Aluminum (Type 4)	\$ 4.30

V. LENS TYPE

CODE	DESCRIPTION	LIST
PLL	Pilot Light Lens	\$11.00

VI. LENS COLOR

CODE	COLOR
AR	Amber
BE	Blue
CR	Clear
GN	Green
RD	Red
WE	White

VII. OPTIONS

CODE	DESCRIPTION	LIST
(Blank)	None	—
IP20	IP20 Guard	\$ 4.00

NOTE: IP20 terminal guards are not available for RTL.

DISCOUNT SCHEDULE **E**

DUAL INPUT REMOTE TEST

Our unique Dual Input Remote light unit can be used as a pilot light while also permitting the testing of a number of lights from a single push button. A diode circuit isolates the test supply from the normal supply. The schematic shown represents a typical dual input application.

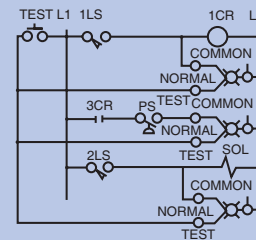

AVAILABLE LENS COLORS FOR PILOT LIGHTS



30MM PILOT LIGHTS

Our 30mm Pilot Lights, when utilized with our LED lamps provide leakage protection, long-lasting life and high quality with tremendous resistance to shock and vibration. Our reflection technology and state-of-the-art LED lamps improve visibility from all angles. c3controls LED lamps last 100,000 hours – *that's 11.4 years!* Combine these LEDs with our full voltage or resistor packages for optimum durability. All c3controls 30mm operators are UL Listed and are rated Type 4/4X as standard for watertight and corrosion resistance. In addition, operators are also listed for Type 1, 2, 3, 3R, 12 and 13, and meet global standards requirements.

Product features include:

- Polyester construction for superior corrosion resistance, moisture rejection and electrical insulation.
- Full voltage lights incorporate a unique insulated socket design to minimize accidental contact during lamp change.
- All lights use miniature bayonet base lamps to provide reliable lamp secureness.
- Available with Incandescent, Neon, or our LED lamps with leakage protection.
- #6 terminal screws with self-lifting captive wire clamps accommodate #22 through two #12 AWG wires (0.5 - 4mm²) per terminal.
- Operators conveniently mount in a round 1-13/64" (30.5mm) hole that is directly interchangeable with competitors units and eliminates the labor required for notching.



30MM INDUSTRIAL PILOT DEVICES

UNIQUE PRODUCT FEATURES



1. Compact, thin design is also vibration resistant.
2. Our seal is infused with a coating to eliminate cracking when exposed to harsh conditions such as heat, dryness and sunlight. This seal also acts as a light reflector because it is white which increases light output and improves visibility from all angles.
3. Our rugged Lexan™ lenses provide better visibility and can resist high impact for reliable performance in most environments, even in high ambient temperatures.
4. We utilize premium 130V incandescent and LED lamps for improved, long-lasting life.

SOME OF OUR POPULAR CONFIGURATIONS:

PILOT LIGHTS WITH POLYESTER CLAMP RING (TYPE 4X)

CATALOG NUMBER	DESCRIPTION	LIST
FVLU120LG-PLLGN	Full Voltage 120V Green LED w/Green Lens	\$75.00
FVLU120LR-PLLRD	Full Voltage 120V Red LED w/Red Lens	\$75.00
FVLU120LA-PLLAR	Full Voltage 120V Amber LED w/Amber Lens	\$75.00

IT'S EASY TO BUILD YOUR OWN PILOT LIGHT

Simply pick the code number from each of the sections below and combine them to build your part number.

Push-To-Test Pilot Lights*



Example: To build one of our most popular Pilot Lights, the part number would be **I + PTT + III + IV + V + VI + VII + VIII** or **FVPTT120-IPBCRD**

*NOTE: Our push-to-test pilot lights must be ordered as an assembled part.

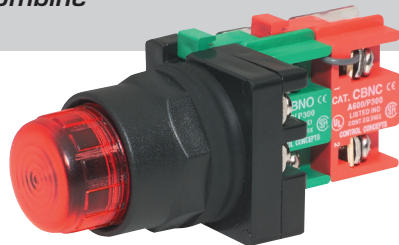

I. PUSH-TO-TEST OPERATOR

CODE	DESCRIPTION	LIST
FV	Full Voltage	\$46.00
RL	Resistor	\$57.00

II. OPERATOR TYPE

CODE	DESCRIPTION	LIST
PTT	Push-To-Test	\$32.00

III. VOLTAGE BASED ON OPERATOR

CODE	DESCRIPTION
FULL VOLTAGE	
6	6V AC/DC
12	12V AC/DC
24	24V AC/DC
120	120V AC/DC
RESISTOR	
120	120V AC/DC
240	240V AC/DC
480	480V AC/DC (LED & Neon only)

Push-To-Test Pilot Lights combine an illuminated push button with normally open and normally closed contact blocks factory wired for three-point wiring in standard push-to-test circuits.

IV. LAMP TYPE/COLOR

CODE	COLOR	LIST
LED		
LA	Amber	\$18.00
LB	Blue	\$18.00
LG	Green	\$18.00
LR	Red	\$18.00
LW	White	\$18.00
INCANDESCENT		
(Blank)	Clear [†]	—
†NOTE: Incandescent bulbs are not an option for RLPTT480.		
F	Clear Flashing Bulb*	\$ 7.10
*NOTE: Incandescent flashing bulbs available for any 6V full voltage application.		
NEON†		
NG	Green	—
NR	Red	—
†NOTE: Only Available in FVPTT120, RLPTT240 and RLPTT480.		
NL	No Lamp	-\$ 1.80

V. CLAMP RING

CODE	DESCRIPTION	LIST
(Blank)	Black Polyester (Type 4X)	—
A	Aluminum (Type 4)	\$ 4.30

VI. LENS TYPE

CODE	DESCRIPTION	LIST
IPBC	Illuminated Push Button Lens	\$24.00
IPBCM	Illuminated Push Button Mushroom Lens	\$36.00
GIPBC	Guarded Illuminated Push Button Lens*	\$36.00
SIPBCM	Shrouded Illuminated Push Button Mushroom Lens*	\$48.00

*NOTE: Aluminum clamp rings are not an option for GIPBC or SIPBCM.

VII. LENS COLOR

CODE	COLOR
AR	Amber
BE	Blue
CR	Clear
GN	Green
RD	Red
WE	White
YW	Yellow

VIII. OPTIONS

CODE	DESCRIPTION	LIST
(Blank)	None	—
IP20	(3) IP20 Guards*	\$12.00

*NOTE: Includes guards for light module and both contact blocks.

SEE PAGE 33 FOR LAMP REPLACEMENT CHART AND PAGE 34 FOR LAMP TECHNICAL DATA.



AVAILABLE LENS COLORS FOR PUSH-TO-TEST PILOT LIGHTS

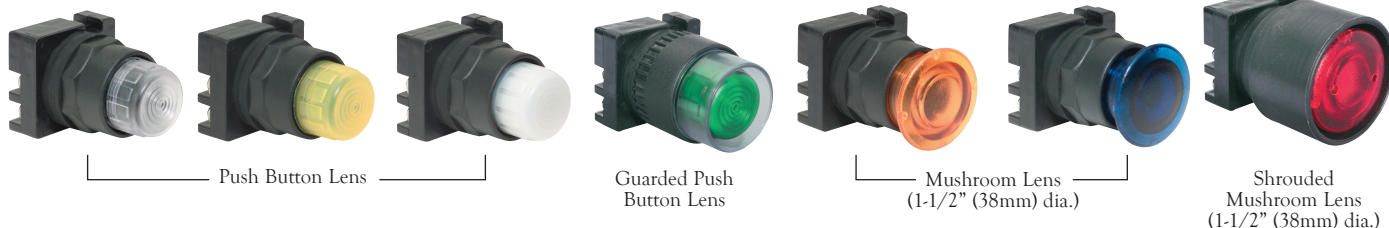

30MM PUSH-TO-TEST PILOT LIGHTS

Our 30mm Illuminated Push-To-Test Pilot Lights, when utilized with our LED lamps provide leakage protection, long-lasting life and high quality with tremendous resistance to shock and vibration. Our reflection technology and state-of-the-art LED lamps improve visibility from all angles. c3controls LED lamps last 100,000 hours – *that's 11.4 years!* Combine these LEDs with our full voltage or resistor packages for optimum durability. All c3controls 30mm operators are UL Listed and are rated Type 4/4X as standard for watertight and corrosion resistance. In addition, operators are also listed for Type 1, 2, 3, 3R, 12 and 13, and meet global standards requirements.

Product features include:

- Polyester construction for superior corrosion resistance, moisture rejection and electrical insulation.
- Full voltage lights incorporate a unique insulated socket design to minimize accidental contact during lamp change.
- All lights use miniature bayonet base lamps to provide reliable lamp secureness.
- Available with Incandescent, Neon, or our LED lamps with leakage protection.
- #6 terminal screws with self-lifting captive wire clamps accommodate #22 through two #12 AWG wires (0.5 - 4mm²) per terminal.
- Operators conveniently mount in a round 1-13/64" (30.5mm) hole that is directly interchangeable with competitors units and eliminates the labor required for notching.

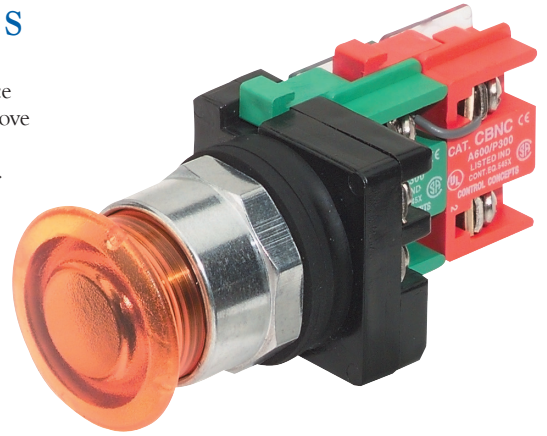

30MM INDUSTRIAL PILOT DEVICES

UNIQUE PRODUCT FEATURES



1. Our push-to-test pilot lights aid in the troubleshooting of the circuit.
2. Our seal is infused with a coating to eliminate cracking when exposed to harsh conditions such as heat, dryness and sunlight. This seal also acts as a light reflector because it is white which increases light output and improves visibility from all angles.
3. Our rugged Lexan™ lenses provide better visibility and can resist high impact for reliable performance in most environments, even in high ambient temperatures.
4. We utilize premium 130V incandescent and LED lamps for improved, long-lasting life.

WIRING DIAGRAM

Customer connections of line and test power supplies. Light unit is powered by the line circuit. Depressing the lens cap will disconnect the line and connect the test supply, confirming bulb status.

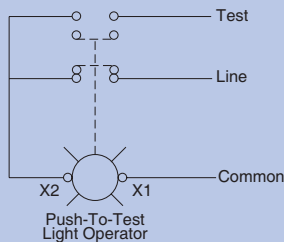

SOME OF OUR POPULAR CONFIGURATIONS:

PUSH-TO-TEST PILOT LIGHTS W/POLYESTER CLAMP RING (TYPE 4X)

CATALOG NUMBER	DESCRIPTION	LIST
FVPTT120-IPBCAR	Full Voltage 120V w/Incandescent Lamp & Amber Lens	\$102.00
FVPTT120-IPBCGN	Full Voltage 120V w/Incandescent Lamp & Green Lens	\$102.00
FVPTT120-IPBCRD	Full Voltage 120V w/Incandescent Lamp & Red Lens	\$102.00

IT'S EASY TO BUILD YOUR OWN PILOT LIGHT

Simply pick the code number from each of the sections below and combine them to build your part number.

20-277V Multi-Voltage Pilot Lights



Example: To build one of our most popular Pilot Lights, the part number would be **I + II + III + IV + PLL + VI + VII** or **30MV20-277DLW-PLLRD**



I. OPERATOR TYPE

CODE	DESCRIPTION	LIST
30MV20-277	Non-Relampable Multi-Voltage Pilot Light	\$107.00

II. LED LAMP FUNCTION

CODE	DESCRIPTION
D	Standard

SEE PAGE 33 FOR LAMP REPLACEMENT CHART AND PAGE 34 FOR LAMP TECHNICAL DATA.

III. LED LAMP COLOR

CODE	COLOR	LIST
LW	White	—

IV. CLAMP RING

CODE	DESCRIPTION	LIST
(Blank)	Black Polyester (Type 4X)	—
A	Aluminum (Type 4)	\$ 4.30

c3controls LED lamps last 100,000 hours — that's 11.4 years!

V. LENS TYPE

CODE	DESCRIPTION	LIST
PLL	Pilot Light Lens	\$ 11.00

VI. LENS COLOR

CODE	COLOR
AR	Amber
BE	Blue
CR	Clear
GN	Green
RD	Red
WE	White

VII. OPTIONS

CODE	DESCRIPTION	LIST
(Blank)	None	—
IP20	IP20 Guard	\$ 4.00

DISCOUNT SCHEDULE **E**

SOME OF OUR POPULAR CONFIGURATIONS:

MULTI-VOLTAGE PILOT LIGHTS

CATALOG NUMBER	DESCRIPTION	LIST
30MV20-277DLW-PLLAR	Multi-Voltage 20-277V, Non-Relampable w/ White LED and Amber Lens	\$118.00
30MV20-277DLW-PLLGN	Multi-Voltage 20-277V, Non-Relampable w/ White LED and Green Lens	\$118.00
30MV20-277DLW-PLLRD	Multi-Voltage 20-277V, Non-Relampable w/ White LED and Red Lens	\$118.00

AVAILABLE LENS COLORS FOR MULTI-VOLTAGE PILOT LIGHTS



30MM MULTI-VOLTAGE PILOT LIGHTS

When you match up our 30mm Pilot Lights with our LED lamps you get a quality, long-lasting, leakage protected pilot device that withstands shock and vibration. Our state-of-the-art LED lamps last 100,000 hours—that's 11.4 years! And we nest them in a bright white cup that casts light through two lenses scored to improve visibility from all angles. c3controls' 30mm multi-voltage pilot lights are UL listed and rated Type 4/4X as standard to resist water and corrosion. In addition, these lights are listed for Type 1, 2, 3, 3R, 12 and 13, and meet global standards.

Product features include:

- Polyester construction for superior corrosion resistance, moisture rejection and electrical insulation.
- #6 terminal screws with self-lifting captive wire clamps to accommodate #22 through two #12 AWG wires (0.5 - 4mm²) per terminal.
- Bi-polar design means functionality is independent of which lead is connected to each terminal.
- Rugged Lexan™ lenses can resist high impact for reliable performance in most environments—even in high ambient temperatures.
- Superior performance even in high vibration and shock applications.
- Enhanced safety with field installable IP20 terminal guards are transparent to maintain terminal visibility. Their construction provides easy access to the device terminals—so wiring is convenient and quick, and they snap securely in place without tools.

For your convenience when marking terminals, our IP20 guards use Series WTB2 markers (see Section 22 Page 32), simplifying wiring and troubleshooting.



UNIQUE PRODUCT FEATURES

c3
Exclusive!

ELIMINATE THE HEADACHE OF MULTIPLE LIGHTS TO MATCH MULTIPLE VOLTAGES!

Our state-of-the-art, super bright LEDs and printed circuit boards allow you to operate this light at any voltage from 20V to 277V AC or DC without losing light intensity or consuming a lot of power. One light unit covers a lot of applications, reducing your inventory! All you have to do is choose your lens color.

- Wider operating voltage range of 20V-277V AC or DC.
- Depth behind the panel at 1-11/16" / 42.8mm.
- Integrated light circuit protection. We included a fusible link in the electronic circuit, resulting in predictable failure mode (open circuit) and improving reliability.
- A redesigned circuit allows you to use the light unit in a wider range of applications, including electronic and coil applications where leakage current and voltages may exist.



IT'S EASY TO BUILD YOUR OWN SELECTOR SWITCH

Simply pick the code number from each of the sections below and combine them to build your part number.

Selector Switches



Example: To build one of our most popular Selector Switches, the part number would be **I + II + III + IV + V + VI + VII** or **SSO3-SHWE-NO/NO**

*NOTE: Contact block configurations are based on circuit designations (see charts below).

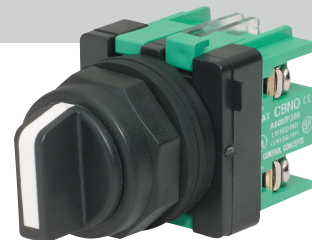

I. SELECTOR SWITCH OPERATOR FUNCTION

CODE	POS./FUNCTION	LIST
SSO2	2/Maintained	\$23.00
SROLR	2/Spring Return, L to R	\$41.00
SRORL	2/Spring Return, R to L	\$41.00
SSO3	3/Maintained	\$23.00
SROLC	3/Spring Return, L to C	\$41.00
SRORC	3/Spring Return, R to C	\$41.00
SROLRC	3/Spring Return, L & R to C	\$41.00
SSO4	4/Maintained	\$23.00
SRO43	4/Spring Return, Pos. 4 to 3	\$41.00
SRO1243	4/Spring Return, Pos. 1 to 2 and Pos. 4 to 3	\$41.00

II. CLAMP RING

CODE	DESCRIPTION	LIST
(Blank)	Black Polyester (Type 4X)	—
A	Aluminum (Type 4)	\$ 4.30

III. HANDLE TYPE

CODE	DESCRIPTION	LIST
SH	Standard	\$ 9.80
SL	Lever	\$ 9.80

IV. HANDLE INSERT COLOR

CODE	COLOR
BE	Blue
GN	Green
GY	Grey
RD	Red
WE	White
YW	Yellow

V. CONTACT BLOCK CONFIGURATION (LEFT SIDE)

CODE	DESCRIPTION	LIST
(Blank)	Operator without Contact Blocks	—
NO	1 Normally Open Contact Block	\$13.00
NC	1 Normally Closed Contact Block	\$13.00
EM	1 Early Make Contact Block	\$17.00
DB	1 Delayed Break Contact Block	\$17.00
NO-NO	2 Normally Open Contact Blocks	\$26.00
NC-NC	2 Normally Closed Contact Blocks	\$26.00
NO-NC	1 Normally Open and 1 Normally Closed Contact Blocks	\$26.00

VI. CONTACT BLOCK CONFIGURATION (RIGHT SIDE)

CODE	DESCRIPTION	LIST
(Blank)	Operator without Contact Blocks	—
NO	1 Normally Open Contact Block	\$13.00
NC	1 Normally Closed Contact Block	\$13.00
EM	1 Early Make Contact Block	\$17.00
DB	1 Delayed Break Contact Block	\$17.00
NO-NO	2 Normally Open Contact Blocks	\$26.00
NC-NC	2 Normally Closed Contact Blocks	\$26.00
NO-NC	1 Normally Open and 1 Normally Closed Contact Blocks	\$26.00

VII. OPTIONS

CODE	DESCRIPTION	LIST/PC*
(Blank)	None	—
IP20	IP20 Guard	\$ 4.00

*NOTE: When choosing the IP20 option, in order to achieve IP20 protection a terminal guard must be assembled on each contact block configuration, increasing the List price \$4.00 for each guard.

Each operating handle is black with a factory assembled color insert.

DISCOUNT SCHEDULE **E**

CONTACT BLOCK SELECTION FOR 2-POSITION SELECTOR SWITCHES

CIRCUIT DESIG.	HANDLE POSITION		BLOCK CATALOG NUMBER	MOUNTING POSITION
	LEFT	RIGHT		
A	O	X	CBNO	EITHER
B	X	O	CBNC	EITHER

O = OPEN X = CLOSED

CONTACT BLOCK SELECTION FOR 3-POSITION SELECTOR SWITCHES

CIRCUIT DESIG.	HANDLE POSITION			BLOCK CATALOG NUMBER	MOUNTING POSITION
	LEFT	CENTER	RIGHT		
C	X	O	O	CBNO	LEFT
D	O	X	O	CBNC	EITHER
E	O	O	X	CBNO	RIGHT
F	O	X	X	CBDB	LEFT
G	X	O	X	CBEM	EITHER
H	X	X	O	CBDB	RIGHT

CONTACT BLOCK SELECTION FOR 4-POSITION SELECTOR SWITCHES

CIRCUIT DESIG.	HANDLE POSITION				BLOCK CAT. #	MOUNTING POSITION
	LEFT	LT. CNT.	RT. CNT.	RIGHT		
I	X	O	O	O	CBNO	LEFT
J	O	X	O	O	CBNC	RIGHT
K	O	O	X	O	CBNC	LEFT
L	O	O	O	X	CBNO	RIGHT
M	O	X	X	X	CBDB	LEFT
N	X	O	X	X	CBEM	RIGHT
O	X	X	O	X	CBEM	LEFT
P	X	X	X	O	CBDB	RIGHT

30MM NON-ILLUMINATED SELECTOR SWITCHES

With our unique universal cam design, c3controls Selector Switches offer multiple functions in a single device eliminating the need to install separate devices to perform individual functions based on contact block configuration. All operators feature polyester housings, are UL Listed, and are rated Type 4/4X as standard for watertight and corrosion resistance. In addition, operators are also listed for Type 1, 2, 3, 3R, 12 and 13, and meet global standards requirements. Add-on contact blocks are available for up to 8 circuits per operator. See pages 4 & 5 for our complete line of 30mm standard contact blocks.

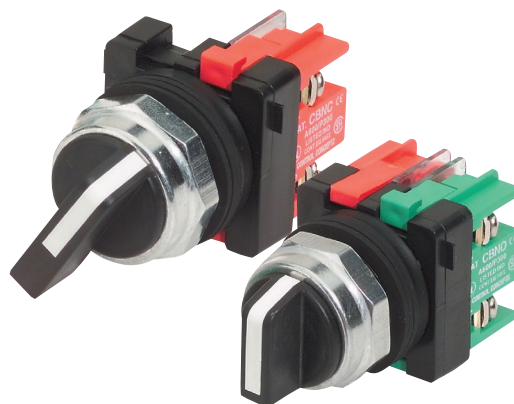

HANDLE POSITIONS					
2-POSITION		3-POSITION		4-POSITION	

30MM INDUSTRIAL PILOT DEVICES

UNIQUE PRODUCT FEATURES

SAVE TIME & MONEY - WITH c3CONTROLS, ONE CAM DOES IT ALL!

1. One-Cam does it all vs. our competitors who need up to fifteen cams to perform the same function. This One-Cam design eliminates the need for multiple cam configurations and selector switch configuration nightmares, saving time, inventory, money, and ensuring 100% cam selection configuration accuracy.

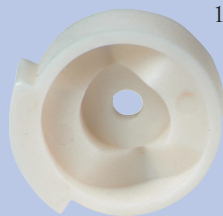

2. Our revolutionary U-Cup seal is infused with a Teflon coating to eliminate cracking when exposed to harsh conditions such as heat, dryness and sunlight.



3. All frictional parts are molded with an internal self-lubricant to provide outstanding wear and smooth cam operations without troublesome greases used by others that attracts dust and other particles in the area.

SOME OF OUR POPULAR CONFIGURATIONS:

2-POSITION SELECTOR SWITCH OPERATORS WITH POLYESTER CLAMP RING (TYPE 4X)										
CONTACT SYMBOL	CONTACT BLOCK MOUNTING POS. <small>Viewed from front of operator</small>	HANDLE POSITION		TYPE OF OPERATOR	MAINTAINED POSITION		SPRING RETURN FROM RIGHT TO LEFT		SPRING RETURN FROM LEFT TO RIGHT	
		O=OPEN	X=CLOSED		CATALOG #	LIST	CATALOG #	LIST	CATALOG #	LIST
	EITHER	0	X	STANDARD	SS02-SHWE-NO	\$45.80	SRORL-SHWE-NO	\$63.80	SROLR-SHWE-NO	\$63.80
				LEVER	SS02-SLWE-NO	\$45.80	SRORL-SLWE-NO	\$63.80	SROLR-SLWE-NO	\$63.80
	EITHER	X	0	STANDARD	SS02-SHWE-NC	\$45.80	SRORL-SHWE-NC	\$63.80	SROLR-SHWE-NC	\$63.80
				LEVER	SS02-SLWE-NC	\$45.80	SRORL-SLWE-NC	\$63.80	SROLR-SLWE-NC	\$63.80

3-POSITION SELECTOR SWITCH OPERATORS WITH POLYESTER CLAMP RING (TYPE 4X)													
CONTACT SYMBOL	CONTACT BLOCK MOUNTING POS. <small>Viewed from front of operator</small>	HANDLE POSITION			TYPE OF OPERATOR	MAINTAINED POSITION		SPRING RETURN FROM LEFT TO CENTER		SPRING RETURN FROM RIGHT TO CENTER		SPRING RETURN FROM LEFT OR RIGHT TO CENTER	
		O=OPEN	X=CLOSED			CATALOG #	LIST	CATALOG #	LIST	CATALOG #	LIST	CATALOG #	LIST
	LEFT	X	0	0	STANDARD	SS03-SHWE-NO/NO	\$58.80	SROLC-SHWE-NO/NO	\$76.80	SRORC-SHWE-NO/NO	\$76.80	SROLRC-SHWE-NO/NO	\$76.80
	RIGHT	0	0	X	LEVER	SS03-SLWE-NO/NO	\$58.80	SROLC-SLWE-NO/NO	\$76.80	SRORC-SLWE-NO/NO	\$76.80	SROLRC-SLWE-NO/NO	\$76.80

MIX AND MATCH ANY INSERT COLOR AND SELECTOR SWITCH HANDLE



IT'S EASY TO BUILD YOUR OWN SELECTOR SWITCH

Simply pick the code number from each of the sections below and combine them to build your part number.

Keyed Selector Switches



Example: To build one of our most popular Keyed Selector Switches, the part number would be **I + II + III + IV + V + VI** or **KOSS2KA-NO**

*NOTE: Contact block configurations are based on circuit designations (see page 26 for circuit designation charts).



I. CLAMP RING

CODE	DESCRIPTION	LIST
(Blank)	Black Polyester (Type 4X)	—
A	Aluminum (Type 4)	\$ 4.30

II. KEYED SELECTOR SWITCH OPERATOR FUNCTION

CODE	POS./FUNCTION	AVAIL. KEY REMOVAL POSITION(S)	LIST
KOSS2	2/Maintained	KA,KR,KL	\$101.00
KOSRRL	2/Spring Return, R to L	KL	\$117.00
KOSRLR	2/Spring Return, L to R	KR	\$117.00
KOSS3	3/Maintained	KA,KR,KL,KC, KLR,KLC,KRC	\$101.00
KOSRLC	3/Spring Return, L to C	KC,KR,KRC	\$117.00
KOSRRC	3/Spring Return, R to C	KC,KL,KLC	\$117.00
KOSRLRC	3/Spring Return, L&R to C	KC	\$117.00
KOSS4	4/Maintained*	KA	\$101.00

*NOTE: Consult factory for special key removal positions (not available for guaranteed same day shipping).

III. KEY REMOVAL POSITION

CODE	REMOVAL POSITION
KA	All
KR	Right Only
KL	Left Only
KC	Center Only
KLR	Left & Right Only
KLC	Left & Center Only
KRC	Right & Center Only

IV. CONTACT BLOCK CONFIGURATION (LEFT SIDE)

CODE	DESCRIPTION	LIST
(Blank)	Operator without Contact Blocks	—
NO	1 Normally Open Contact Block	\$ 13.00
NC	1 Normally Closed Contact Block	\$ 13.00
EM	1 Early Make Contact Block	\$ 17.00
DB	1 Delayed Break Contact Block	\$ 17.00
NO-NO	2 Normally Open Contact Blocks	\$ 26.00
NC-NC	2 Normally Closed Contact Blocks	\$ 26.00
NO-NC	1 Normally Open and 1 Normally Closed Contact Blocks	\$ 26.00

V. CONTACT BLOCK CONFIGURATION (RIGHT SIDE)

CODE	DESCRIPTION	LIST
(Blank)	Operator without Contact Blocks	—
NO	1 Normally Open Contact Block	\$ 13.00
NC	1 Normally Closed Contact Block	\$ 13.00
EM	1 Early Make Contact Block	\$ 17.00
DB	1 Delayed Break Contact Block	\$ 17.00
NO-NO	2 Normally Open Contact Blocks	\$ 26.00
NC-NC	2 Normally Closed Contact Blocks	\$ 26.00
NO-NC	1 Normally Open and 1 Normally Closed Contact Blocks	\$ 26.00

VI. OPTIONS

CODE	DESCRIPTION	LIST/PC*
(Blank)	None	—
IP20	IP20 Guard	\$ 4.00

*NOTE: When choosing the IP20 option, in order to achieve IP20 protection a terminal guard must be assembled on each contact block configuration, increasing the List price \$4.00 for each guard.

DISCOUNT SCHEDULE **E**

KEYED SWITCH OPTIONS

Alternate Key Combinations: Up to 9 different key combinations (CC series) are available. To order locks keyed differently, consult factory or specify on order and increase the List price \$60.00 per operator.

Master Keys: A master key is available that works in all 9 CC series key combinations. To order, specify part number MS MK1250 (\$43.00 per set of two master keys).

Extra or Replacement Keys: Available for standard keyed selector switches only. To order, specify part number ES201 (\$8.60 per set of two keys). NOTE: Two keys come standard with each operator.

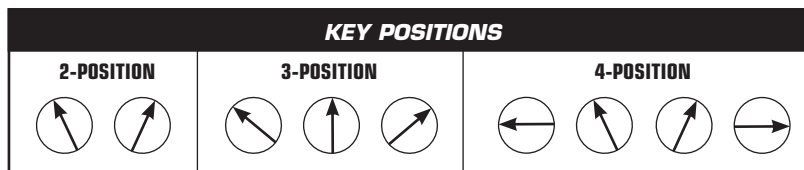

30MM KEYED SELECTOR SWITCHES

c3controls Keyed Selector Switches offer multiple functions in a single device eliminating the need to install separate devices with individual functions based on contact block configuration. All operators feature polyester housings and all locks are premium quality brass for superior corrosion resistance. Keys are made of extra heavy brass for long life. Our Keyed Selector Switches are UL Listed and are rated Type 4/4X as standard. In addition, operators are also listed for Type 1, 2, 3, 3R, 12 and 13, and meet global standards requirements. We also offer you the opportunity to choose the appropriate clamp ring for your specific work environment; polyester clamp rings, which are designed to provide you with a modern appearance, or polished aluminum clamp rings for those who prefer a shiny rugged metal appearance. Add-on contact blocks are available for up to 8 contacts per operator. See pages 4 & 5 for our complete line of 30mm standard contact blocks.



30MM INDUSTRIAL PILOT DEVICES

UNIQUE PRODUCT FEATURES



SAVE TIME & MONEY - WITH C3CONTROLS, ONE CAM DOES IT ALL!

1. One-Cam does it all vs. our competitors who need up to fifteen cams to perform the same function. This One-Cam design eliminates the need for multiple cam configurations and selector switch configuration nightmares, saving time, inventory, money, and ensuring 100% cam selection configuration accuracy.
2. Our revolutionary U-Cup seal is infused with a Teflon coating to eliminate cracking when exposed to harsh conditions such as heat, dryness and sunlight.
3. All frictional parts are molded with an internal self-lubricant to provide outstanding wear and smooth cam operations without troublesome greases used by others that attract dust and other particles in the area.

SOME OF OUR POPULAR CONFIGURATIONS:

2-POSITION KEYED SELECTOR SWITCH OPERATORS WITH POLYESTER CLAMP RING (TYPE 4X)										
CONTACT SYMBOL	CONTACT BLOCK MOUNTING POS. <small>Viewed from front of operator</small>	HANDLE POSITION O=OPEN X=CLOSED		TYPE OF OPERATOR	MAINTAINED POSITION		SPRING RETURN FROM RIGHT TO LEFT		SPRING RETURN FROM LEFT TO RIGHT	
		LEFT	RIGHT		CATALOG #	LIST	CATALOG #	LIST	CATALOG #	LIST
1 NO 	EITHER	0	X	Key Removal Pos L R L & R	KOSS2KL-NO KOSS2KR-NO KOSS2KA-NO	\$114.00 \$114.00 \$114.00	KOSRRLKL-NO — —	\$130.00 — —	— KOSRLRKR-NO —	— \$130.00 —
1 NC 	EITHER	X	0	Key Removal Pos L R L & R	KOSS2KL-NC KOSS2KR-NC KOSS2KA-NC	\$114.00 \$114.00 \$114.00	KOSRRLKL-NC — —	\$130.00 — —	— KOSRLRKR-NC —	— \$130.00 —

3-POSITION KEYED SELECTOR SWITCH OPERATORS WITH POLYESTER CLAMP RING (TYPE 4X)													
CONTACT SYMBOL	CONTACT BLOCK MOUNTING POS. <small>Viewed from front of operator</small>	HANDLE POSITION O=OPEN X=CLOSED			TYPE OF OPERATOR	MAINTAINED POSITION		SPRING RETURN FROM LEFT TO CENTER		SPRING RETURN FROM RIGHT TO CENTER		SPRING RETURN FROM LEFT OR RIGHT TO CENTER	
		LEFT	CENTER	RIGHT		CATALOG #	LIST	CATALOG #	LIST	CATALOG #	LIST	CATALOG #	LIST
NO/NO 	LEFT RIGHT	X 0	0 0	0 X	Key Rem Pos L R C	KOSS3KL-NO/NO KOSS3KR-NO/NO KOSS3KC-NO/NO	\$127.00 \$127.00 \$127.00	— KOSRLCKR-NO/NO KOSRLCKC-NO/NO	— \$143.00 \$143.00	KOSRRCKL-NO/NO — KOSRRCKC-NO/NO	\$143.00 — \$143.00	— — KOSRLCKC-NO/NO	— — \$143.00
					Key Rem Pos L & R L & C R & C	KOSS3KLR-NO/NO KOSS3KLC-NO/NO KOSS3KRC-NO/NO	\$127.00 \$127.00 \$127.00	— — KOSRLCKRC-NO/NO	— — \$143.00	— KOSRRCKLC-NO/NO —	— \$143.00 —	— — —	— — —

IT'S EASY TO BUILD YOUR OWN LEGEND PLATE

Simply pick the code number from each of the sections below and combine them to build your part number.

Legend Plates



Legend plates feature 2 lines of text with approximately 16 characters per line. Upper case is standard unless specified.

*The tall legend plate (LPT) features 3 lines of text with approximately 16 characters per line and the Potentiometer legend plate comes standard with a scale and one or two lines of text, see chart D below.

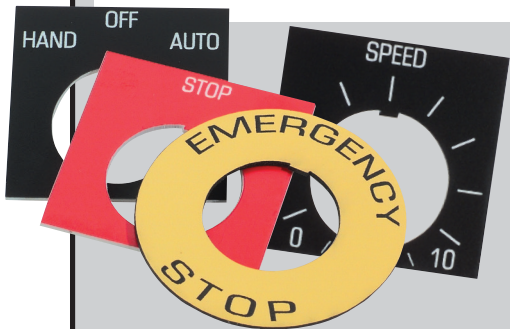

I. LEGEND PLATE TYPE

CODE	DESCRIPTION	LIST
LP	Standard 2" h x 2" w	\$ 4.00
LPN	Narrow 2" h x 1-3/4" w	\$ 4.00
LPS	Short 1-3/4" h x 2" w	\$ 4.00
LPT	Tall 2-1/4" h x 2" w*	\$ 5.00
LPR	Standard Round 2-13/32" Dia.	\$ 9.00
LPRM	Medium Round 2-3/4" Dia.	\$11.00
LPRJ	Jumbo Round 3-3/4" Dia.	\$12.00

II. FACE AND LETTER COLOR

CODE	FACE COLOR	LETTER COLOR
AL	Aluminum	Black
(Blank)	Black	White
BE	Blue	White
GN	Green	White
RD	Red	White
WE	White	Black
YW	Yellow	Black

III. LEGEND DESIGNATION

A. PUSH BUTTONS AND LIGHTS

CODE	DESCRIPTION
00	(Blank)
01	AUTO
02	CLOSE
31	CYCLE START
100	CYCLE STOP
03	DOWN
102	EMERGENCY
04	EMERGENCY STOP
06	FAST
101	FAULT
07	FORWARD
08	HAND
32	HIGH
33	IN
09	INCH
10	JOG
38	JOG FORWARD
39	JOG REVERSE
34	LOW
35	LOWER
11	MANUAL
26	MOTOR RUN
12	OFF
13	ON
14	OPEN
36	OUT
27	OVERLOAD
15	POWER OFF
16	POWER ON
30	PUSH TO RESET
17	PUSH TO TEST
37	RAISE
109	READY
18	RESET
19	REVERSE
20	RUN
21	SLOW
22	START
23	STOP
24	TEST
29	TRIP
25	UP

B. 2-POSITION SELECTOR

CODE	LEGEND LEFT	LEGEND RIGHT
00	(Blank)	(Blank)
50	AUTO	HAND
68	AUTO	MANUAL
51	DOWN	UP
63	FAST	SLOW
52	FWD	REV
53	HAND	AUTO
73	HIGH	LOW
54	INCH	RUN
75	LEFT	RIGHT
70	LOCAL	REMOTE
55	MANUAL	AUTO
56	OFF	ON
57	ON	OFF
58	OPEN	CLOSE
65	PULL START	PUSH STOP
66	PUSH OFF	PULL ON
64	PUSH ON	PUSH OFF
67	PUSH TO STOP	PULL TO START
71	RAISE	LOWER
59	REV	FWD
60	RUN	JOG
69	SLOW	FAST
61	START	STOP
62	STOP	START
74	SUMMER	WINTER
72	UP	DOWN

C. 3-POSITION SELECTOR

CODE	LEGEND LEFT	LEGEND CENTER	LEGEND RIGHT
00	(Blank)	(Blank)	(Blank)
108	A	O	H
92	AUTO	OFF	HAND
93	AUTO	MAN	OFF
80	DOWN	OFF	UP
81	FWD	AUTO	REV
82	FWD	OFF	REV
107	H	O	A
83	HAND	OFF	AUTO
94	HIGH	OFF	LOW
99	JOG	OFF	AUTO
90	LOCAL	OFF	REMOTE
84	MANUAL	OFF	AUTO
89	OFF	RUN	START
85	OFF	START	RUN
86	OFF	1	2
95	OPEN	OFF	CLOSE
91	RAISE	OFF	LOWER
96	SLOW	OFF	FAST
97	SUMMER	OFF	WINTER
98	UP	OFF	DOWN
87	1	OFF	2
88	1	2	3

D. POTENTIOMETER*

CODE	DESCRIPTION
40	Blank Legend 0 - 10
41	"SPEED" 0 - 10
43	Blank Legend 0 - 100
44	"SPEED" 0 - 100

IV. ADHESIVE BACK

CODE	DESCRIPTION
(Blank)	No Adhesive Back
A	Adhesive Back



IT'S EASY TO BUILD YOUR OWN LEGEND PLATE

Simply pick the code number from each of the sections below and combine them to build your part number.

Special Legend Plates



All legend plates are a 2-ply laminated plastic, laser engraved for a permanent and quality appearance. Uppercase is standard unless specified.



I. LEGEND PLATE TYPE

CODE	DESCRIPTION	LIST
LP	Standard 2" h x 2" w	\$ 4.00
LPN	Narrow 2" h x 1-3/4" w	\$ 4.00
LPS	Short 1-3/4" h x 2" w	\$ 4.00
LPT	Tall 2-1/4" h x 2" w*	\$ 5.00
LPR	Standard Round 2-13/32" Dia.	\$ 9.00
LPRM	Medium Round 2-3/4" Dia.	\$ 11.00
LPRJ	Jumbo Round 3-3/4" Dia.	\$ 12.00

Legend plates feature 2 lines of text with approximately 16 characters per line.
*The tall legend plate (LPT) features 3 lines of text with 16 characters per line.

II. FACE AND LETTER COLOR

CODE	FACE COLOR	LETTER COLOR
AL	Aluminum	Black
(Blank)	Black	White
BE	Blue	White
GN	Green	White
RD	Red	White
WE	White	Black
YW	Yellow	Black

Upon receipt of your order, legend plates will be set-up as specified and a proof will be sent to you prior to production to ensure accuracy.

To order, submit your drawing to:

Mail: c3controls
Attn: Customer First
PO Box 496
Beaver, PA 15009

Fax: 724.775.5283

Email: legendplates@c3controls.com

To help simplify your order process, templates are available by calling our factory at 724.775.7926 or reference one of the drawings shown on page 42.

Special legend plates are not available for same day shipping.



III. LEGEND DESIGNATION

CODE	DESCRIPTION	LIST
SP	Special Legend	\$14.00

IV. ADHESIVE BACK

CODE	DESCRIPTION
(Blank)	No Adhesive Back
A	Adhesive Back

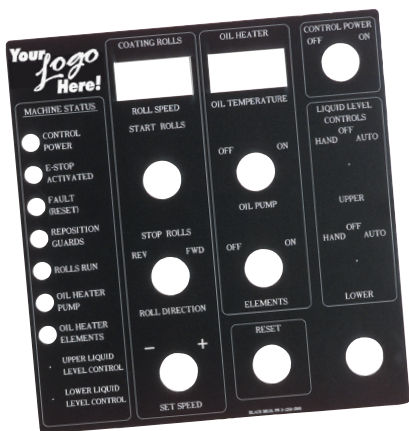

(Sample custom plate)

CUSTOM LEGEND PLATES

- **Add your Corporate Logo!** Send us your corporate logo electronically to promote your company image in a clean professional legend plate.
- Available in 2-ply 12" x 24" (304.8mm x 609.6mm) sheets of laminated plastic for custom laser engraving.
- To order, specify part number LP-CP (no adhesive back) or LP-CP-A (adhesive back).
- Initial Set-Up Fee Per Legend Plate: \$50/hour (minimum fee \$50.00).
- \$2.00/Square Inch (minimum \$18.00).
- Design services available. Consult factory for details and hourly rate.
- Custom legend plates are not available for same-day shipping.

To order, submit your drawing to:

Mail: c3controls
Attn: Customer First
PO Box 496
Beaver, PA 15009

Fax: 724.775.5283

Email: legendplates@c3controls.com

EXTENDED CLAMP RINGS



We offer four types of 30mm extended clamp rings that guard against accidental operation. Use our Extended Clamp Rings (ECR or AECR) with flush caps, our Clear Guarded Clamp Ring (EECR) with illuminated push buttons and our Large Extended Clamp Ring (LECR) with flush or extended caps, which also provides easier access to your push buttons.

FOR USE WITH NON-ILLUMINATED CAPS

CODE	DESCRIPTION	LIST
ECR	Extended Ring	\$ 6.00
LECR	Large Extended Ring	\$10.00
AECR	Aluminum Extended Ring	\$10.00

FOR USE WITH ILLUMINATED LENS

CODE	DESCRIPTION	LIST
EECR	Guarded Clear Polyester Ring	\$ 8.00

PANEL GASKETS



Our panel gaskets are constructed of Neoprene for long life and low compression set and provide a watertight seal. Panel gaskets are supplied to accommodate different panel thickness. In order to meet Type 4/4X requirements, at least one 1/16" (1.6mm) gasket must be used. NOTE: All c3controls 30mm operators are provided with gaskets.

CODE	DESCRIPTION	LIST
PG2	1/16" (1.6mm) Gasket	\$ 1.00
PG6	3/16" (4.8mm) Gasket	\$ 1.00

THRUST & TRIM WASHERS



Anti-rotation device for use with 30mm push buttons, selector switches and pilot lights to provide additional protection from rotation and aid in alignment. This product is optional with c3controls gasket technology.

CODE	DESCRIPTION	LIST
TTW	30mm Anti-Rotation Washers	\$ 4.00

LAMP REMOVAL TOOL



Used to facilitate the removal of lamps particularly in illuminated push buttons and push-to-test operators.

CODE	DESCRIPTION	LIST
LRT	Lamp Removal Tool	\$ 8.00

LOCK OFF ATTACHMENTS

c3controls offers a wide variety of 30mm corrosive resistant lock-off attachments for maintained and momentary push buttons and selector switches. Our LOAX, LOAM and LOAP lock-offs permit locking operators in the depressed position. Our LOAFC lock-off covers and locks the operator so its position cannot be changed and features a 1/4" (6.4mm) diameter padlocking hasp.



CODE	FITS	LIST
LOAX	Standard Extended Cap	\$32.00
LOAM	Standard Momentary Mushroom Cap	\$32.00
LOAP	Push-Pull Maintained Mushroom Cap (PPMC) or Push Maintained Extended Cap (PMXC)	\$32.00
LOAFC	Most Push Buttons and Selector Switches	\$50.00

GUARD ATTACHMENT



Our PPGD guards against accidental operation and is made of a high strength polyester material.

CODE	FITS	LIST
PPGD	Maintained Push Buttons	\$40.00

HOLE PLUG



Use to seal unused panel holes. Our hole plug comes with additional sealing panel gaskets to ease installation and is rated Type 4X.

CODE	DESCRIPTION	LIST
HP	30mm Grey Hole Plug	\$11.00

CLAMP RING WRENCH



To simplify tightening and loosening of standard polyester and aluminum 1-3/8" (34.9mm) octagonal clamp rings. Won't scratch your lens or panel.

CODE	DESCRIPTION	LIST
CRW	30mm Clamp Ring Wrench	\$20.00

PUSH MAINTAINED FLUSH AND EXTENDED CAPS

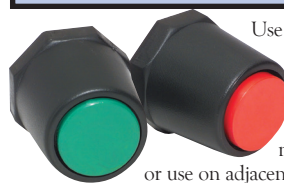

Use with a secondary standard cap and mechanical interlock to provide two button momentary/maintained operation or use on adjacent operators with mechanical interlock to provide two-button maintained/maintained operation.

COLOR	FLUSH CODE	EXTENDED CODE	LIST
WITH BLACK POLYESTER (TYPE 4X) CLAMP RING			
Black	PMFCBK	PMXCBK	\$44.00
Green	PMFCGN	PMXCGN	\$44.00
Red	PMFCRD	PMXCRD	\$44.00
Yellow	PMFCYW	PMXCYW	\$44.00
WITH ALUMINUM (TYPE 4) CLAMP RING			
Black	APMFCBK	APMXCBK	\$48.00
Green	APMFCGN	APMXCGN	\$48.00
Red	APMFCRD	APMXCRD	\$48.00
Yellow	APMFCYW	APMXCYW	\$48.00

MECHANICAL INTERLOCK



Our Mechanical Interlock features a 2" (50.8mm) center and can be used to interlock two adjacent operators. This may also be used to interlock a two-unit maintained/momentary assembly. NOTE: Factory installation recommended.

CODE	DESCRIPTION	LIST
MI	30mm Mechanical Interlock	\$48.00

IP20 TERMINAL GUARDS



Our IP20 terminal guards protect against accidental contact with live parts and can be ordered separately as an accessory or factory installed providing the convenience of a single catalog number. NOTE: IP20 terminal guards must be installed before wiring. For factory installed guards, refer to the operator page to determine the appropriate part number. For terminal marking convenience, our guards can be utilized with Series WTB2 markers (see Section 22 Page 32).

CODE	FITS	LIST
CBIP20	Standard Contact Blocks	\$ 4.00
FVIP20	Full Voltage Illuminated Push Button Operators, Pilot Lights, Push-To-Test Light Modules and Multi-Voltage Pilot Lights	\$ 4.00
MLIP20	Resistor Momentary Illuminated Push Button Operators and Pilot Lights	\$ 4.00



LED, INCANDESCENT & NEON REPLACEMENT LAMPS

c3controls offers a full range of lamp options in a miniature bayonet base for direct interchangeability which provides flexibility in choosing the best lamp for each installation application. Multiple voltage options in Incandescent, LED and Neon lamps are available. Please refer to the chart at the bottom of the page to determine the appropriate replacement lamp based on your operator voltage. For lamp technical data, see page 34.

LED Lamps



To order LED Lamps, the part number would be **LED + II + III**

I. LAMP TYPE

CODE	DESCRIPTION	LIST
LED	LED Lamp	\$28.00

Our LED lamps feature built-in leakage protection.

II. VOLTAGE

CODE	DESCRIPTION
6	6V
12	12V
24	24V
130	130V

III. LAMP COLOR

CODE	COLOR
AR	Amber
BE	Blue
GN	Green
RD	Red
WE	White

Incandescent Lamps



CODE	VOLTAGE	LIST
FVB6	6V	\$ 4.00
FVB12	12V	\$ 4.00
FVB24	24V	\$ 4.00
FVB55	55V	\$ 8.00
FVB120	120V	\$ 8.00
FVB6F	*6V Flashing	\$12.00

*NOTE: There may be a 5-15 second delay before flashing begins.

Neon Lamps



CODE	VOLTAGE	COLOR	LIST
FVB120NG	120V	Green	\$ 9.00
FVB120NR	120V	Red	\$ 9.00

DISCOUNT SCHEDULE **E**

30MM REPLACEMENT LAMP REFERENCE CHART (FOR REFERENCE ONLY - USE CHARTS ABOVE TO ORDER)

OPERATOR CODE	OPERATOR VOLTAGE	LED (ALL COLORS)	INCANDESCENT	NEON
FVLU6	Full Voltage 6V AC/DC	LED6	FVB6 or FVB6F	—
FVLU12	Full Voltage 12V AC/DC	LED12	FVB12	—
FVLU24	Full Voltage 24V AC/DC	LED24	FVB24	—
FVLU120	Full Voltage 120V AC/DC	LED130	FVB120	FVB120NG or FVB120NR
RLU120L	Resistor 120V AC/DC*	LED24	—	—
RLU120I	Resistor 120V AC/DC*	—	FVB55	—
RLU240L	Resistor 240V AC/DC*	LED24	—	—
RLU240I	Resistor 240V AC/DC*	—	FVB120	—
RLU240N	Resistor 240V AC/DC*	—	—	FVB120NG or FVB120NR
RLU480	Resistor 480V AC/DC*	LED130	—	FVB120NG or FVB120NR
RTL6	Dual Input 6V AC/DC	LED6	FVB6	—
RTL12	Dual Input 12V AC/DC	LED12	FVB12	—
RTL24	Dual Input 24V AC/DC	LED24	FVB24	—
RTL120L	Dual Input 120V AC/DC	LED130	—	—
RTL120I	Dual Input 120V AC/DC	—	FVB55	—

*NOTE: Lamps are unique to Resistor Light Units. Refer to side of light unit for correct replacement lamp part number.

30MM INDUSTRIAL PILOT DEVICES

ELECTRICAL RATINGS								
Lamp	Industry Number	Rated Volts	Lumens (MSCD)	Design Life (Hrs.)	Current Draw (mA)	Lamp Type	Shock & Vibration	Leakage Protection
FVB6	1866	6.3V	0.65	5,000	250	Incandescent	Very Good	N/A
FVB12	756	14V	0.31	15,000	80	Incandescent	Good	N/A
FVB24	757	28V	0.62	7,500	80	Incandescent	Good	N/A
FVB55	1835	55V	1.1	5,000	50	Incandescent	Good	N/A
FVB120	**	130V	0.36	10,000	20	Incandescent	Good	N/A
LED6	**	6V†	Varies w/ Color 2000 mcd Typical	100,000	50	LED	Excellent	14 mA
LED12	**	12V†		100,000	<20	LED	Excellent	4 mA
LED24	**	24V†		100,000	<20	LED	Excellent	4 mA
LED130	**	120/130V†		100,000	<10	LED	Excellent	2 mA
FVB120NG	—	95-135V	Typical (Glow)	25,000	<5	Neon/Green	Very Good	N/A
FVB120NR	—	95-135V	Typical (Glow)	25,000	<5	Neon/Red	Very Good	N/A

**Designates a lamp design optimized for c3controls illuminated devices. See LED replacement lamps on page 33.

† LED voltage tolerance is +/- 10%

MULTI-VOLTAGE POWER CONSUMPTION & CURRENT DRAW

System Voltage	AC Current Draw (mA)	DC Current Draw (mA)	Power Consumption (W)
24V	21	20	AC: <1 DC: <1/2
48V	17	7	
120V	3.5	—	
125V	—	3	
240V	2.5	—	
250V	—	2	
277V	2.5	—	

PROTECTION FEATURES

Fused to Fail Open

Yes

DIELECTRIC STRENGTH (TERMINAL TO GROUND)

2200V for 1 Minute

STANDARD CONTACTS

Utilization Category

	IEC	UL	Make Rating	Break Rating	Ith-Thermal Current
AC	AC-15	A600	7200VA	720VA	10A
DC	DC-13	P300	138VA	138VA	5A

NOTE: For AC voltage below 72V AC the max. allowed switching current is 10A = Ith. For DC voltages below 28V DC the max. allowed switching current is 5A = Ith.

For switching applications below 24V/40mA - Hermetic REED contacts are recommended. Hermetic Reeds are also excellent in environments containing chemical vapors, oxidizing agents, and explosive gases. Please refer to the HAZARDOUS section of the Series 30 devices for more information. Available on c3controls' 30MM products only.

	UNITS	
ENVIRONMENTAL RATINGS		
Operators		Rated and Certified for use in Type 1, 2, 3, 3R, 4/4X, 12, & 13 and IP65
Operating Temperature	°F / °C	-40 to +131 / -40 to +55
Storage Temperature	°F / °C	-40 to +185 / -40 to +85

NOTE: Operating environments below freezing temperatures are assumed to be absent of freezing liquids or pollutants.

TERMINAL & WIRING CONSIDERATION

AWG Conductor		22-12 CU (Copper only - Solid & Stranded) [.5 ~ 4mm ²] One or two wires permitted per termination
Recommended Torque	in-Lb. [Nm]	7 - 10 [0.8 - 1.0]

CONSTRUCTION

OPERATING FORCES

PUSH BUTTONS (OPERATORS ONLY)

Momentary	lbs. [N]	1.3 [5.8]
Illuminated Momentary	lbs. [N]	2.8 [12.4]
Maintained	lbs. [N]	4 - 6 [17.9 - 26.7]
Illuminated Maintained	lbs. [N]	4.6 [20.5]

30MM INDUSTRIAL PILOT DEVICES		
	UNITS	
CONSTRUCTION (CONTINUED)		
OPERATING FORCES (CONTINUED)		
RESET PUSH BUTTON	lbs. [N]	1.5 [6.7]
SELECTOR SWITCHES		
Maintained	in-lbs. [Nm]	1.7 [.19]
Momentary	in-lbs. [Nm]	1.7 [.19]
Key Operated	in-lbs. [Nm]	1.7 [.19]
CABLE PULL		
Standard	lbs. [N]	4 – 6 [17.9 – 26.7]
Heavy Duty	lbs. [N]	13 [57.8]
PUSH-TWIST RELEASE	lbs. [N]	4.7 [20.9]
POTENTIOMETER		
2 Watt "J" Series	in-oz. [Nm]	3 – 12 [.11 Max.] (300° Rotation)
STANDARD CONTACT BLOCKS	lbs. [N]	1 [4.45]
INDICATING LIGHTS		Refer to the appropriate Lamp Data
MULTI-VOLTAGE LIGHTS	VAC/VDC	20-277 (Burden .816W Max.)
MECHANICAL ENDURANCE		
PUSH BUTTONS		
Maintained	Ops.	250,000
Momentary	Ops.	5,000,000
SELECTOR SWITCHES	Ops.	500,000
ALL OTHER DEVICES	Ops.	250,000
STANDARD CONTACT BLOCKS	Ops.	10,000,000
INDICATING LIGHTS	Ops.	Refer to the appropriate Lamp Data
MATERIALS		
Operator Housings		Thermoplastic Polyester and Polyester Blends (UV Stabilized for outdoor use)
Operator Caps and Handles - Non-Illuminated (Glass Reinforced Grades)		Thermoplastic Polyester and Polyester Blends (UV Stabilized for outdoor use)
Mounting Rings and Nuts		Thermoplastic Polyester and Polyester Blends (UV Stabilized for outdoor use)
Thrust Washer		Thermoplastic Polyester and Polyester Blends (UV Stabilized for outdoor use)
Trim Washer		Thermoplastic Polyester and Polyester Blends (UV Stabilized for outdoor use)
Pilot Light Lens		High Impact Polycarbonate (UV Stabilized for outdoor use)
Transparent Push Button and Mushroom Caps		High Impact Polycarbonate (UV Stabilized for outdoor use)
Certain CAM and Bearing Parts		Custom Polymers: Teflon, Silicon and Moly-Disulfide impregnated for improved wearability
Rubber Boots		Custom Polymers: Fluorosilicone and Thermoplastic Neoprene
Seals		Neoprene Gaskets
		Thermoplastic - Molded Neoprene and Alloy Derivitives
		BUNA N - Rubber - Teflon Coated
		Thermoplastic - Elastomer Molded Seals
		Fluorosilicone - Boots
Push Pull Bearings		Brass and Stainless Steel
Internal Tubes for Maintained Devices		Brass and Stainless Steel
Detents for Maintained Devices		Brass and Stainless Steel
Springs		Stainless Steel throughout
Optional Mounting Nut		Aluminum
ROHS COMPLIANCE		For RoHS compliance documentation by product, refer to www.c3controls.com

MOMENTARY & MAINTAINED NON-ILLUMINATED PUSH BUTTONS

Fully-assembled operators come standard with one 3/16" (4.8mm) and three 1/16" (1.6mm) gaskets.
See mounting gasket specifications chart #3 on page 42.

**NON-ILLUMINATED OPERATOR
(SHOWN WITH FLUSH CAP)**

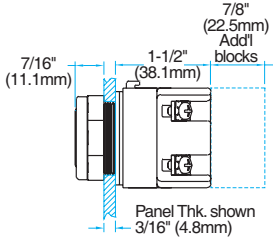

MOMENTARY FLUSH CAP

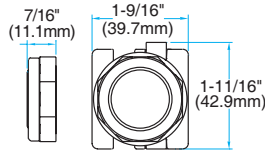

MOMENTARY GUARDED FLUSH CAP

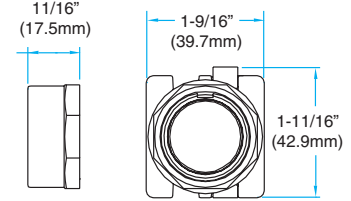

MOMENTARY EXTENDED CAP

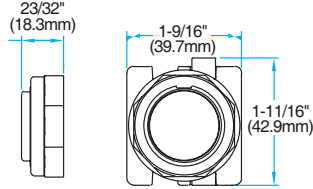

**MOMENTARY GUARDED
EXTENDED CAP**

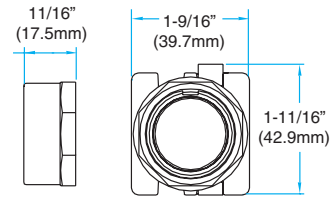

**MOMENTARY STANDARD
RUBBER BOOT**

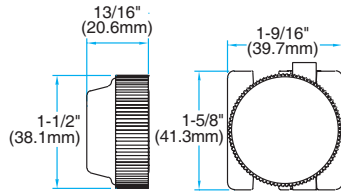

**MOMENTARY 1-1/2" (38MM)
MUSHROOM CAP**

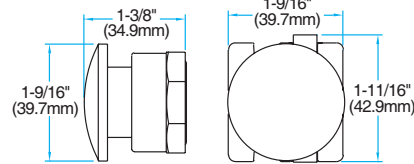

**MOMENTARY 2-1/4" (57.2MM)
JUMBO MUSHROOM CAP**

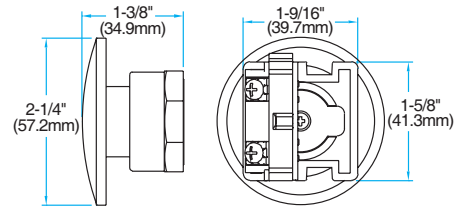

**MOMENTARY FLUROSILICONE
RUBBER BOOT**

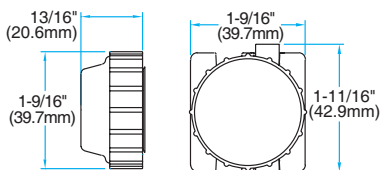

**MOMENTARY 1-1/2" (38MM)
SHROUDED MUSHROOM CAP**

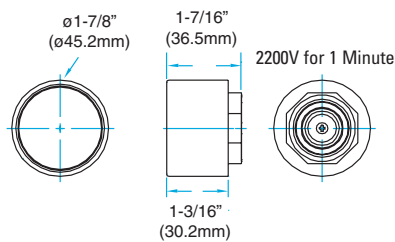

**MOMENTARY 2-1/4" (57.2MM)
SHROUDED JUMBO MUSHROOM CAP**

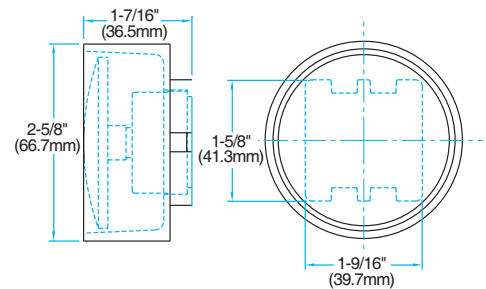

**2-POSITION PUSH-PULL
MAINTAINED 1-1/2" (38MM)
MUSHROOM CAP**

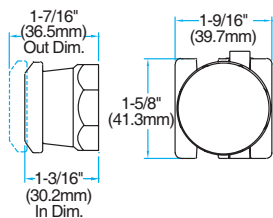

**2-POSITION PUSH-PULL MAINTAINED
2-1/4" (57.2MM) JUMBO MUSHROOM CAP**

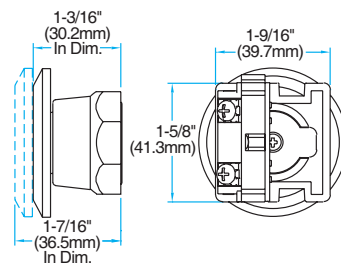

**2-POSITION PUSH-TWIST MAINTAINED
1-1/2" (38MM) MUSHROOM CAP**

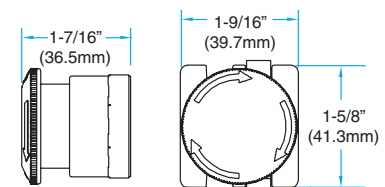

MOMENTARY ILLUMINATED PUSH BUTTONS

Fully-assembled operators come standard with one 3/16" (4.8mm) and three 1/16" (1.6mm) gaskets.
See mounting gasket specifications chart #3 on page 42.

ILLUMINATED FULL VOLTAGE, RESISTOR AND DUAL-INPUT OPERATORS (SHOWN WITH IPBC)

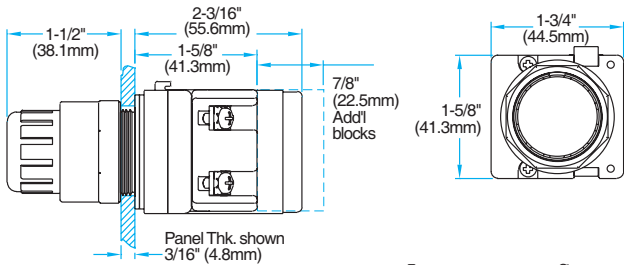

ILLUMINATED FULL VOLTAGE OPERATOR (SHOWN WITH IPBCM)

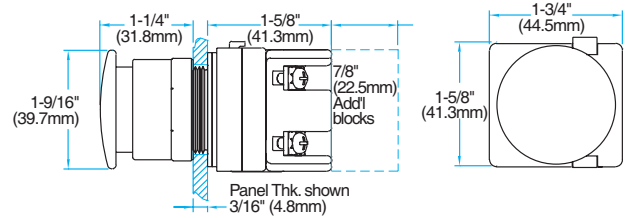

ILLUMINATED SHROUDED MUSHROOM LENS (SIPBCM)

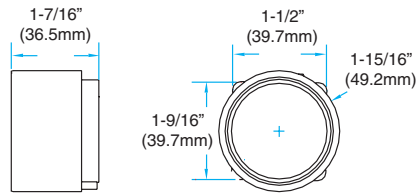

ILLUMINATED GUARDED LENS (GIPBC)

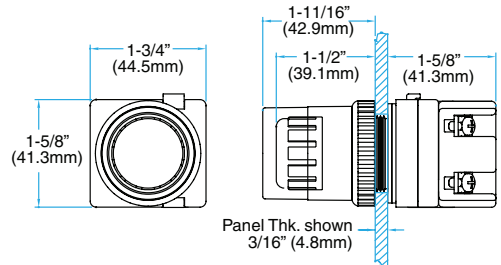

2 & 3 POSITION PUSH-PULL MAINTAINED ILLUMINATED PUSH BUTTONS

Fully-assembled operators come standard with one 3/16" (4.8mm) and three 1/16" (1.6mm) gaskets.
See mounting gasket specifications chart #1 on page 42.

ILLUMINATED FULL VOLTAGE OPERATOR (SHOWN WITH IMC)

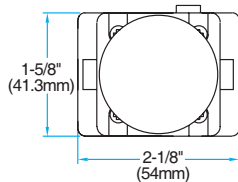
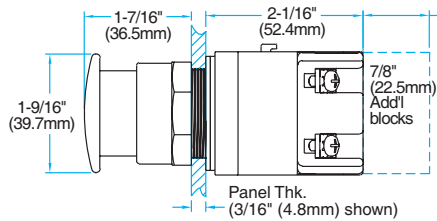

ILLUMINATED RESISTOR OPERATOR (SHOWN WITH IMC)

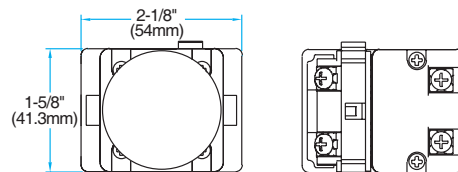
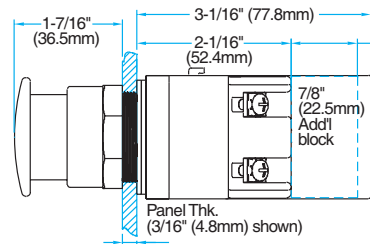

RESET PUSH BUTTON

Fully-assembled operators come standard with one 3/16" (4.8mm) and three 1/16" (1.6mm) gaskets.
See mounting gasket specifications chart #3 on page 42.

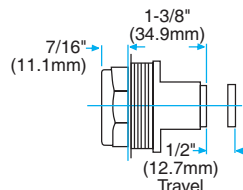

WOBBLE STICK

Fully-assembled operators come standard with one 3/16" (4.8mm) and three 1/16" (1.6mm) gaskets.
See mounting gasket specifications chart #3 on page 42.

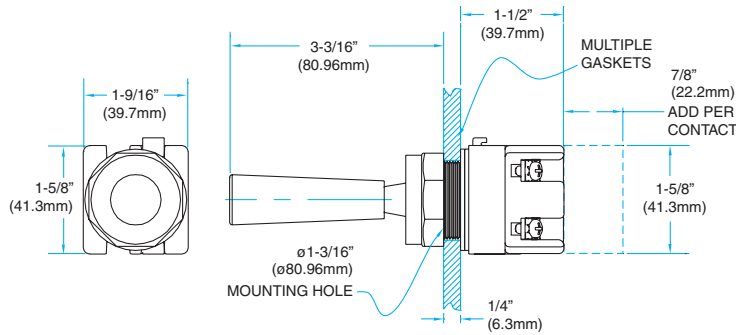

GUARD ATTACHMENT

PPGD

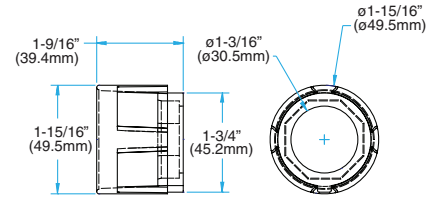

POTENTIOMETER WITH & WITHOUT TERMINAL BLOCK

Fully-assembled operators come standard with one 3/16" (4.8mm) and three 1/16" (1.6mm) gaskets.
See mounting gasket specifications chart #3 on page 42.

POTENTIOMETER OPERATOR (SHOWN WITHOUT TERMINAL BLOCK)

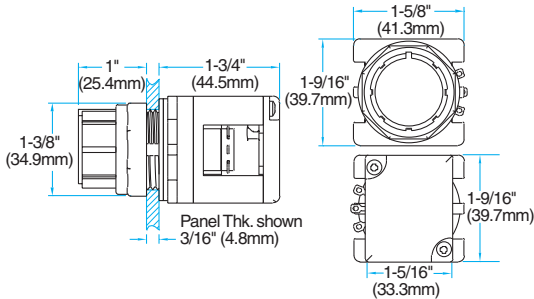

POTENTIOMETER OPERATOR (SHOWN WITH TERMINAL BLOCK)

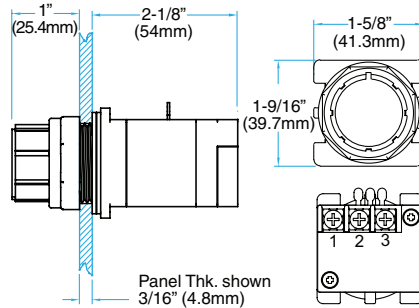

WIRING DIAGRAM

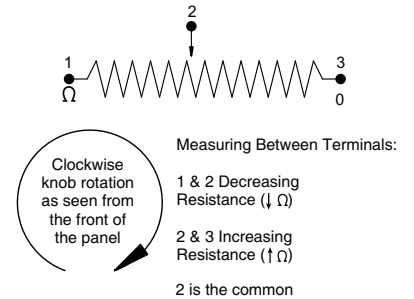

CONTACT BLOCKS

CONTACT BLOCK

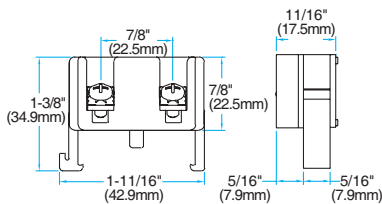

CONTACT BLOCK (SHOWN WITH IP20 TERMINAL GUARD)

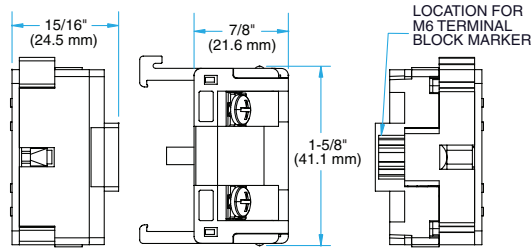

A600 (AC) Rating Designation:

A600 (7200 VA Make and 720 VA Break), 600V AC Maximum, Maximum Continuous Thermal Current, Ith: 10A

P300 (DC) Rating Designation:

P300 (138 VA Make and 138 VA Break), 250V DC Maximum, Maximum Continuous Thermal Current, Ith: 5A

CABLE PULL OPERATORS

Fully-assembled operators come standard with one 3/16" (4.8mm) and three 1/16" (1.6mm) gaskets.
See mounting gasket specifications chart #3 on page 42.

PUSH-PULL MAINTAINED CABLE PULL OPERATOR

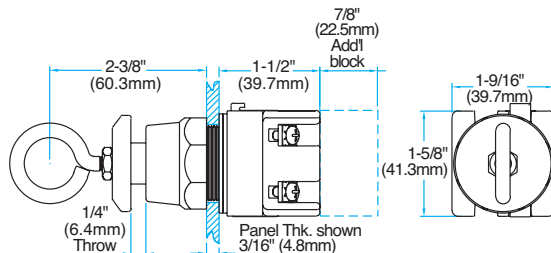

MOMENTARY AND HEAVY DUTY CABLE PULL OPERATORS

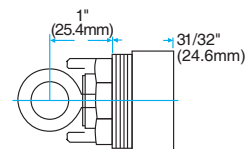

MOMENTARY BOOTED CABLE PULL OPERATOR

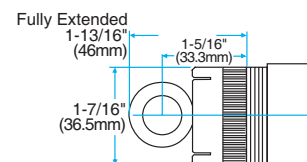

MAINTAINED FLUSH & EXTENDED PUSH BUTTON CAPS

Fully-assembled operators come standard with one 3/16" (4.8mm) and three 1/16" (1.6mm) gaskets.
See mounting gasket specifications chart #3 on page 42.

MAINTAINED FLUSH PUSH BUTTON CAP
(SHOWN WITH AN OPERATOR AND CONTACT BLOCK)

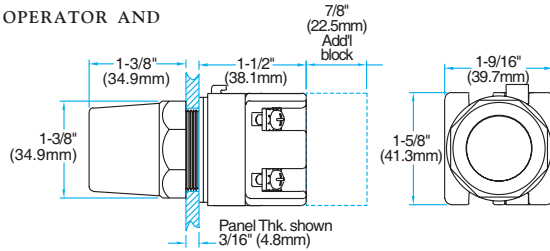

MAINTAINED EXTENDED PUSH BUTTON CAP

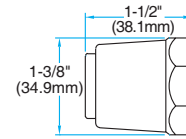

PILOT LIGHTS

Fully-assembled operators come standard with one 3/16" (4.8mm) and two 1/16" (1.6mm) gaskets.
See mounting gasket specifications chart #2 on page 42.

FULL VOLTAGE PILOT LIGHT OPERATOR
(SHOWN WITH PLL AND IP20 TERMINAL GUARD)

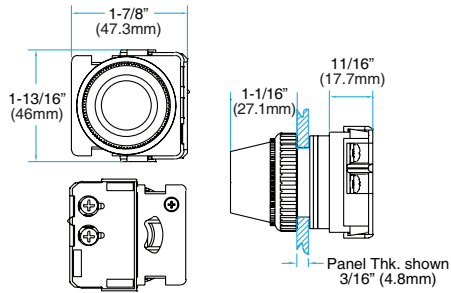

RESISTOR PILOT LIGHT OPERATOR
(SHOWN WITH PLL AND IP20 TERMINAL GUARD)

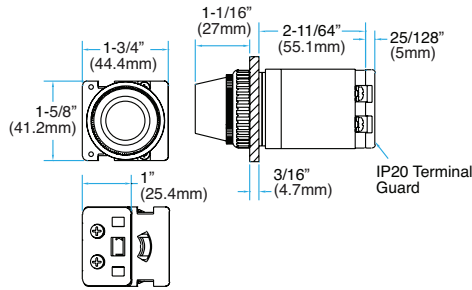

DUAL INPUT PILOT LIGHT OPERATOR
(SHOWN WITH PLL)

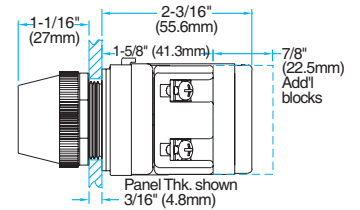

MULTI-VOLTAGE PILOT LIGHT

Fully-assembled operators come standard with four 1/16" (1.6mm) gaskets.
See mounting gasket specifications chart #2 on page 42.

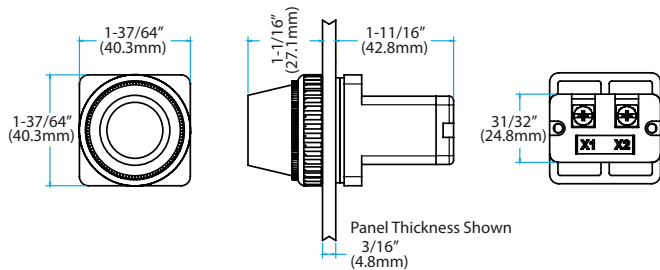

**VISIT WWW.C3CONTROLS.COM TO
DOWNLOAD CAD DRAWINGS**

PUSH-TO-TEST PILOT LIGHTS

Fully-assembled operators come standard with one 3/16" (4.8mm) and three 1/16" (1.6mm) gaskets.
See mounting gasket specifications chart #1 on page 42.

FULL VOLTAGE & RESISTOR PUSH-TO-TEST OPERATORS (SHOWN WITH IPBC)

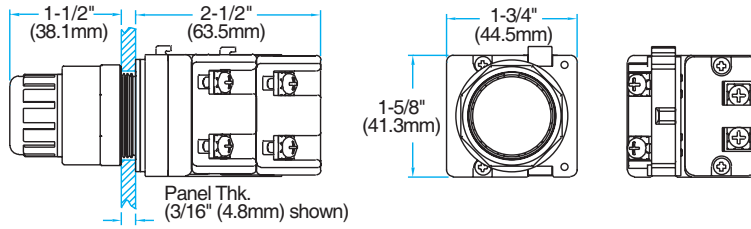

FULL VOLTAGE & RESISTOR PUSH-TO-TEST OPERATORS (SHOWN WITH IPBCM)

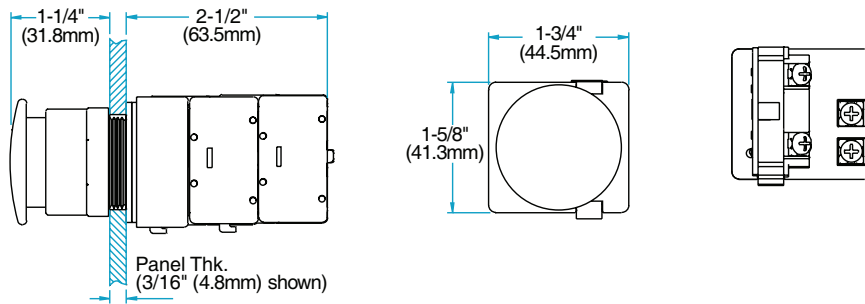

GUARDED LENS

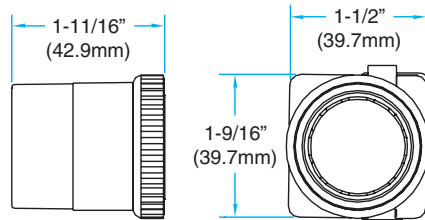

SHROUDED MUSHROOMS LENS

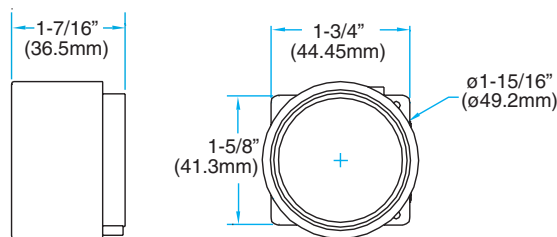

SELECTOR SWITCHES

Fully-assembled operators come standard with one 3/16" (4.8mm) and three 1/16" (1.6mm) gaskets.
See mounting gasket specifications chart #3 on page 42.

SELECTOR SWITCH OPERATOR (SHOWN WITH STANDARD HANDLE)

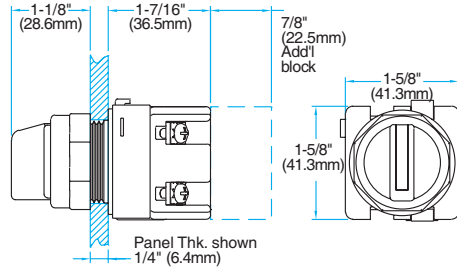

SELECTOR SWITCH LEVER HANDLE

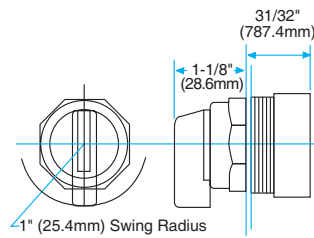

KEYED SELECTOR SWITCH OPERATOR

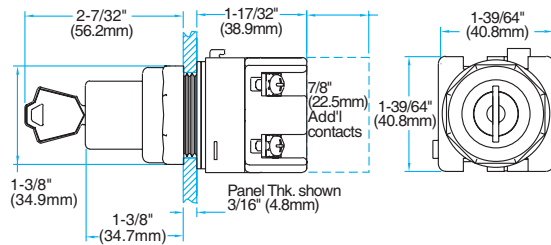

LOCK-OFF ATTACHMENT

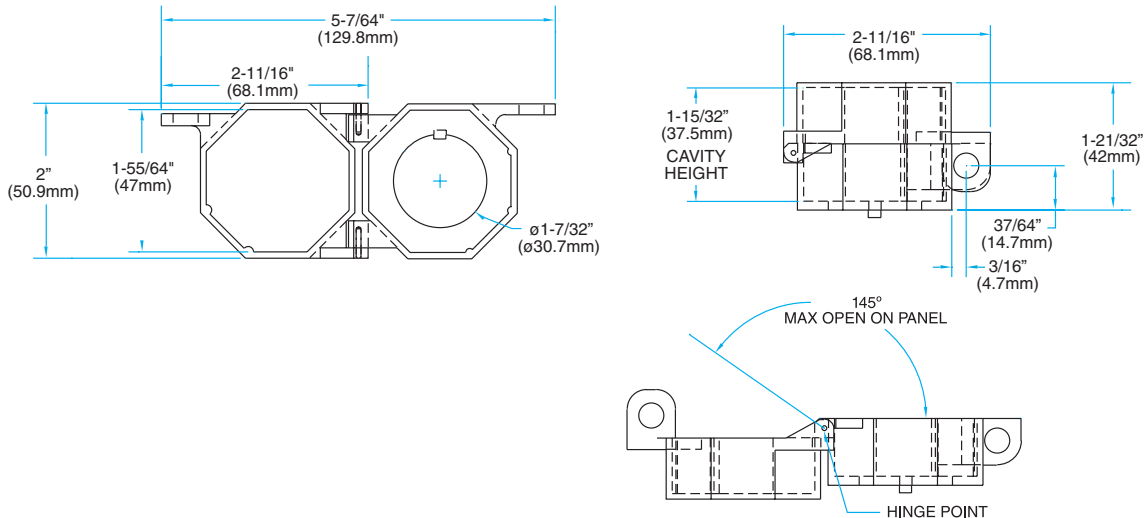

LEGEND PLATES

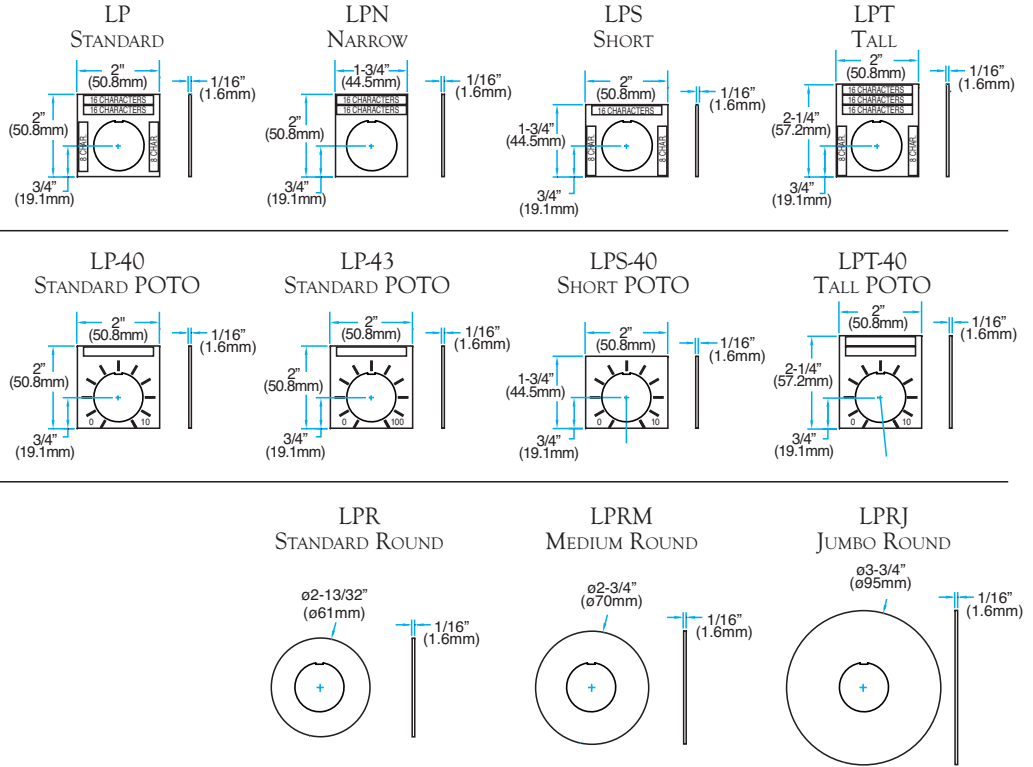
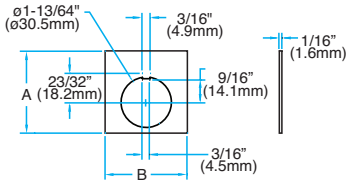

Note: Legend plates feature a tab for optional break-away positioning and can be used in conjunction with the Thrust & Trim Washer accessory.

MOUNTING GASKETS

MOUNTING GASKETS CHART #1

PANEL THICKNESS IN DECIMALS	# OF GASKETS NEEDED 3/16" & 1/16"	
	(4.8MM)	(1.6MM)
less than .080	1	3
.080 - .132	1	2
.133 - .185	1	1
.186 - .238	0	3
.239 - .291	0	2
.292 - .344	0	1

NOTE: Remove one 1/16" (1.6mm) gasket when using a legend plate.

MOUNTING GASKETS CHART #2

PANEL THICKNESS IN DECIMALS	# OF GASKETS NEEDED 3/16" & 1/16"	
	(4.8MM)	(1.6MM)
less than .080	1	2
.080 - .132	1	1
.133 - .185	0	3
.186 - .238	0	2
.239 - .291	0	1

NOTE: Remove one 1/16" (1.6mm) gasket when using a legend plate.

MOUNTING GASKETS CHART #3

PANEL THICKNESS IN DECIMALS	# OF GASKETS NEEDED 3/16" & 1/16"	
	(4.8MM)	(1.6MM)
less than .080	1	5
.080 - .132	1	4
.133 - .185	1	3
.186 - .238	1	2
.239 - .291	1	1
.292 - .344	0	3

NOTE: Remove one 1/16" (1.6mm) gasket when using a legend plate.

MOUNTING HOLE PATTERN

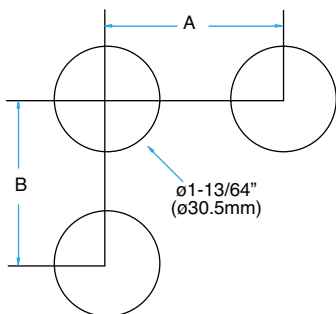

MOUNTING HOLE PATTERN

SPACING	A	B
Minimum	2" (50.8mm)	2" (50.8mm)
Standard	2-1/14" (57.2mm)	2-1/14" (57.2mm)